

Optimization of unloading modes of compressed natural gas that is transported by container ships

*Ye.I. Kryzhanivskyy**, *O.M. Susak*, *Val.V. Zaytsev*

*Ivano-Frankivsk National Technical University of Oil and Gas;
15, Karpatska Str., Ivano-Frankivsk, 76019, Ukraine*

Received: 03.07.2013 Accepted: 10.10.2013

Abstract

The aim of the study is to calculate the parameters of the movable pipeline ship unloading as a part of the cargo plan of a CNG ship, to develop a technological scheme of the pipeline strapping of the containers system, to develop an unloading scheme of a CNG ship under the conditions of the different schemes of mooring, to calculate the parameters of the gas flow during the unloading process.

The scientific novelty of the work is to substantiate the technological strapping of the container blocks in order to make loading/unloading of the CNG vehicle uniform, to determine the required performance of unloading points and to ensure the unloading duration up to 12 hours.

According to the research there is offered the unloading scheme of the CNG vehicle under the conditions of the bow mooring to the port facilities and the presence of the bow and stern containers blocks connections to the pipeline communications.

There are offered two concurrent unloading points with the maximum unloading capacity of 150 kg/s. The further layout of the turbo expander and compressor equipment should result from the offered parameters scheme.

It is proved that the offered pipeline communication scheme provides with the uniform ship unloading (pressure difference in individual containers blocks (0,5–0,7 bar), however, there is a significant uniform (up to -30°C) temperature lowering of the gas due to physical processes of the gas throttling in CNG cylinders. During further research studies it should be considered the impact of the temperature lowering on the mechanical properties of the CNG cylinders composite material. Generally, the offered unloading scheme will allow ship unloading in the economically reasonable period of 12 hours.

The results should be used for further development of the technological scheme of ground equipment for connecting of a CNG vehicle, for choosing the technological equipment, assessing the gas flow parameters influence on the mechanical properties of the pipes metal and the composite material.

Key Words: *CNG cylinders, CNG ship, CNG transport.*

The development strategy of oil and gas sector of Ukraine up to 2030 states that the guarantee of expected natural gas consumption and the sources of its recovery include natural gas production by the Ukrainian companies outside Ukraine. The appropriate countries are the ones with large reserves for the gas production increase on their territories – Algeria, Libya, Iran and others. Iran is a prospective source of gas import to Ukraine. These perspectives are related with the use of the "Nabucco" pipeline that is developed by the INOGATE program under the aegis of the EU. However, due to various objective and subjective factors, these prospects are reducing. In prospect the most promising gas supplier for Ukraine is an Algerian project, but the restrictive factor of this project is the problem of the produced gas transportation to Ukraine. The concept of compressed natural gas transportation by container ships focuses on this problem solving.

Ukrainian scientists offered the concept of marine transportation technology of compressed natural gas (CNG) by container ships [1]. The peculiar feature of the offered technology, in contrast to the technology of marine transportation by CNG ships, is that a container ship is loaded at any seaport container terminal with special 20- or 40-foot sea containers that contain tanks for compressed gas storage. Natural gas can also be downloaded at the offshore gas fields directly in tank containers that are located on the container ships similarly to the CNG ships loading.

Accordingly prepared natural gas is transmitted by a high pressure pipeline from the field into the main high pressure cargo system of the container ship; then it is compressed under the pressure of 20–25 MPa. High pressure pipes of the trunk pipelines combine the blocks of CNG Modules (100–500 items) that are located on the deck and in the holds of a CNG container ship.

Gas is directly unloaded into the gas transmission system or an underground gas holder of Ukraine at appropriate terminals. Compressed natural gas in CNG Modules is unloaded in the gas transmission system through a system of pipelines and reduces the pressure in the CNG Modules according to the GTS specifications. This system doesn't need significant

* Corresponding author:
susak52@gmail.com

investments into construction of marine pipelines and natural gas liquefaction plants in order to deliver it to the market on LNG ships, construction or purchase of CNG gas carriers. The main objects of the investments in this new technology are the special Modules for transportation and storage of compressed natural gas.

The peculiarity of the present stage of the development of CNG technology is the transition of the companies interested in implementation of the natural gas marine transportation projects from conceptual analysis to the detailed engineering design of the basic elements of transmission chain and forming of an international consortia for the practical implementation of CNG projects in different parts of the world. The first CNG ships and commercial transportation of compressed natural gas can appear in 2013–2014.

Several international companies (Ener Sea Transport LLC (USA), Knutsen OAS Shipping i Compressed Energy Technology AS (both – Norwegian), TransCanada Pipeline Ltd., TransOcean Gas Inc., Sea NG Management Corporation (Canadian) are currently working on projects of CNG ships with the natural gas capacity of 3 to 33 million m³ [2–8].

According to their suggestions the following equipment can be boarded on a CNG ship: a device for receiving natural gas from the offshore terminal, the system for complex gas preparation, the system of compressed gas storage, compression system and the system of gas shipment at the offshore receiving terminal. The ship must be equipped with a dynamic positioning system in order to work with offshore terminals.

Building of CNG ships in Ukrainian plants will cost 1.5 cheaper than in foreign shipyards. Due to the low cost of transportation services of Ukrainian CNG ships, the shipowner will be able to maneuver the gas transportation tariffs [1, 9, 10].

According to international experts [4, 11] the transportation of natural gas on CNG ships will cost 1.5–2.0 cheaper than transportation by marine pipelines or by LNG ships in liquefied state with natural gas delivery volumes 0.5–4.0 billion m³ per year with the distances from 250 to 2500 km.

The advantages of compressed natural gas transportation using CNG Modules in comparison with LNG technology are the following:

- the lower cost of gas transportation in comparison with deep pipelines and LNG;
- the ability to design and build quickly and autonomously high pressure CNG Modules;
- experience in designing and building of container ships;
- availability of scientific and technical support;
- there is no need to build regasification plant in the unloading port;
- there is no need for energy expenditure for regasification;
- there is no need for the design and construction of expensive and technically complicated gas carriers for liquefied gas transportation;
- the level of environmental hazards is lower.

There is sufficient scientific and production potential in Ukraine to generate a key element of the new technology – its own competitive CNG ships. There can be built ships with the deadweight up to 80,000 tons, the length up to 300 meters and the width up to 35.0 meters at the Ukrainian shipbuilding yards.

The global "container crisis" is very conducive for the concept of natural gas transportation by CNG container ships.

The consequences of the crisis are: permanently reducing charter rates for container ships since 2008. According to analytical agencies the rates in the direction Asia – the United States declined in the period of November–January 2009 by 12.1%, in the period January 2008 – January 2009 by 14.3%.

The charter rates for the container tonnage are predicted to decline due to the crisis to the end of 2013. This situation means that more container ships stand idle. The number of idle ships that were taken from the service by their owner-operators or that were returned to their owners increased twice during 2009 and in three times in the end of 2010. The number of ships that stand idle is predicted to reach 25%.

That is why the container crisis situation can significantly reduce the cost of gas transportation by CNG Modules.

The comparative natural gas transportation rates are shown in Figure 1.

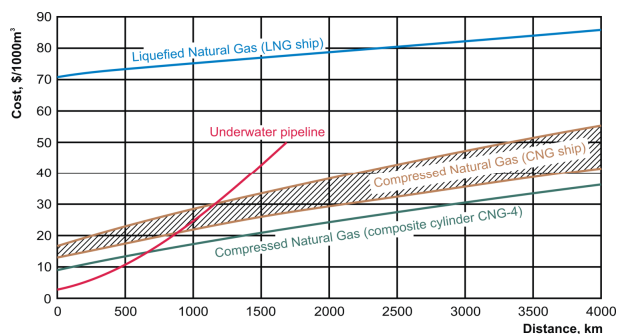

Figure 1 – The comparative natural gas transportation rates (underwater pipeline LNG, CNG)

The method of compressed natural gas transportation by “movable pipelines” can be used according to the offered concept. This means a movable pipeline can be filled with purified compressed natural gas, which is moved by a marine vehicle and unloaded in the final point. The newness of the method is the fact that a pipeline is composed of connected Modules (Figure 2), which dimensions match the dimensions of standard shipping containers (Figure 3) attached to the marine vehicle with the compactly attached high pressure long-length tube (Figure 4). The operations of gas downloading and unloading are carried out through a system of pipelines that connect a movable pipeline with loading-unloading points; the movable pipeline remains at the marine vehicle.

The purpose of this new transportation method is cheaper natural gas transportation, reduction the cost of construction-and-assembling operations and reduction its final price for consumers. The efficiency of compressed

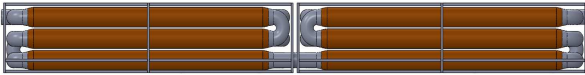

Figure 2 – CNG Modules of the movable pipeline



Figure 3 – A standard shipping container



Figure 4 – A long-length tube of a CNG Module

natural gas transportation by movable pipelines is confirmed by the Ukrainian scientists [1, 12].

Location of CNG Modules in the system of the compressed gas storage and their combination into a movable pipeline must match "cargo plan" of the ship. The container-carrier cargo plan of the movable pipeline should be made according to the general requirements for the optimal location of cargo; the conditions for future sailing should also be considered.

The main list of these requirements is the following:

- ensuring the required ship stability under the different load variations;
- ensuring the safety of the container carrier design and items of a movable pipeline;
- preservation of the trim difference and careen within acceptable limits;
- ensuring the most efficient use of load capacity and load-carrying capacity of the movable pipeline container carrier;
- ensuring acceptable limits of loading and unloading of a movable pipeline container-carrier;
- ensuring the safe operation of the ship in the place of loading / unloading and during transitions;
- ensuring the safety of the transported CNG Modules and natural gas in them;
- ensuring the order of priority of compressed gas loading;
- ensuring the safety standards and occupational safety of the ship crew and port employees;

ensuring the operation economic efficiency of the movable pipeline container carrier.

The aim of the research is to calculate the parameters of the ship unloading as a part of the cargo plan of a CNG ship. It is necessary to have precise information on sailing conditions, specifications of CNG Modules and data about container ship (theoretical drawings, design drawings, etc.) in order to make a comprehensive cargo plan for the movable pipeline container ship.

The basis of the safe navigation of the container ship is its stability, general and local strength, allowable trim difference and careen. For this purpose CNG Modules must be efficiently distributed in width, length and height of the ship. The longitudinal strength of the ship is achieved mainly through efficient load distribution of CNG Modules along the length of the ship. That is why a large mass should be placed in the middle holds, and the lateral compartments of the container ship should not be overloaded.

The coordinates of the gravity centers of each section (block) of the Modules should be determined during allocation of CNG Modules in the compartments of the container ship. The data on the weight of modules blocks, their gravity centers and similar data for all ship reserves and ballast make it possible to calculate the weight moments relatively to the principal axes of the container ship.

A container ship careen should not exceed 3–5° during loading-unloading of CNG Modules, in other case a module will be jammed in guiding cells. In the last resort for the careen reduction one can use careen-trim ballast system.

The number of CNG Modules tiers is defined by the requirements of stability and allowable load on deck and hatch covers.

During operation of movable pipelines container ships it is necessary to control the ship's stability after its loading. The container ship must be equipped with special devices for measuring the careen angle and special careen-ballast tanks. The ship's stability should be monitored during the rolling period.

Assembling of the movable pipeline container ship that is offered by the concept authors [1] for the container ship with a capacity of 2240 FEU (Fourty-foot Equivalent Unit) is shown in Figures 5 and 6.

The movable pipeline of this ship is divided into 7 sections (blocks) with the characteristics listed in Table 1.

To simulate the real properties of the natural gas we can use Soave–Redlich–Kwong equation [13]

$$p = \frac{RT}{V-b} - \frac{a(T)}{V(V+b)}, \quad (1)$$

where p is the absolute pressure; T is the absolute temperature; V is the molar volume; R is the universal gas constant; a , b are constants that depend on the matter properties. Coefficients of the equation a and b for a single gas component depend on the critical pressure and the temperature of the component, uncentricity factor of the substance molecule in such a way.

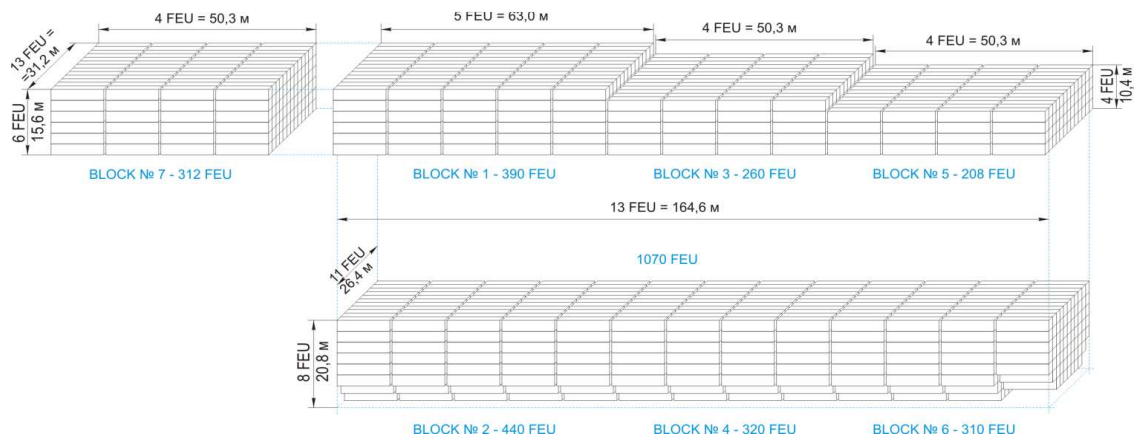

Figure 5 – The layout of CNG Modules of the movable pipeline in the container ship

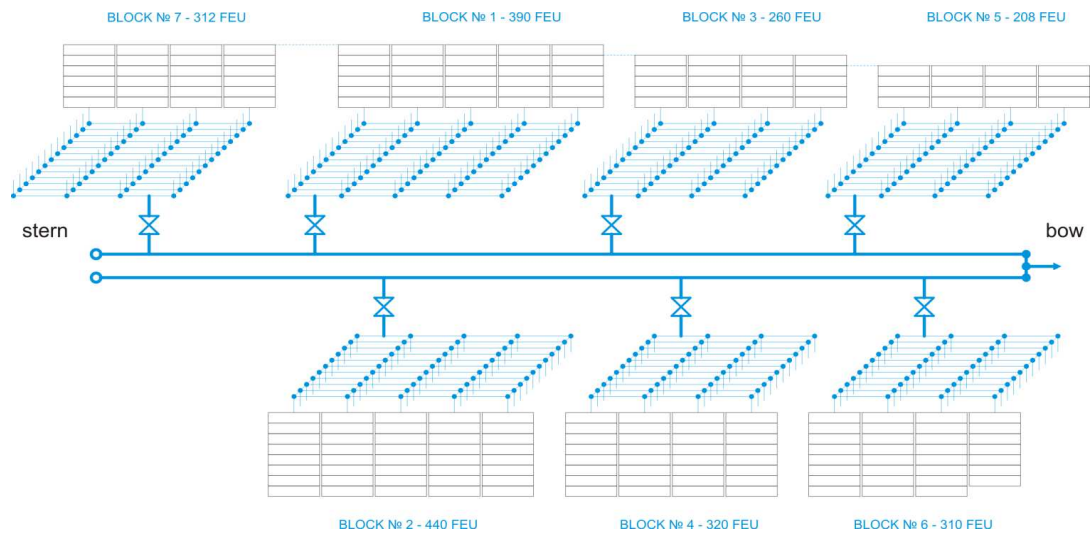

Figure 6 – The scheme of CNG Modules amalgamation into the movable pipeline

Table 1 – Main characteristics of the movable pipeline blocks

| Block # | Capacity, FEU | Total length of the pipe of block Modules, m |
|---------|---------------|--|
| 1 | 390 | 42120 |
| 2 | 440 | 47520 |
| 3 | 260 | 28080 |
| 4 | 320 | 34560 |
| 5 | 208 | 22464 |
| 6 | 310 | 33480 |
| 7 | 312 | 33696 |
| Σ | 2240 | 241920 |

where Ω_a and Ω_b are the coefficients 0,42748 and 0.08664 respectively; T_{cr} is the critical temperature of the gas component, K; p_{cr} is the critical pressure of the gas component, Pa; ω is the uncentricity factor of the substance.

The classical rule of the mixing phases is used for calculation the gas mixtures [14, 15]. The molar fraction of methane in total gas composition is 95%, and it meets the requirements of the current regulations.

The specialized software was used to calculate the parameters of the CNG ship unloading. The equations system of the conservation laws of mass, momentum and energy in order to calculate the stationary processes in general is the following:

$$a(T) = a_{cr} \alpha(T), \quad (2)$$

$$a_{cr} = \Omega_a \frac{R^2 T_{cr}^{2.5}}{P_{cr}}, \quad (3)$$

$$b = \Omega_b \frac{R T_{cr}}{P_{cr}}, \quad (4)$$

$$\alpha(T) = \left(1 + m \left(1 - \left(\frac{T}{T_{cr}} \right)^{0.5} \right) \right)^2, \quad (5)$$

$$m = 0.480 + 1.574 \omega - 0.176 \omega^2, \quad (6)$$

$$\begin{cases} \frac{d}{dx}(\rho v) = 0, \\ \frac{dp}{dx} = -\frac{\lambda v |v|}{2d} \rho - \rho g \sin \alpha, \\ \frac{dh}{dx} = -\frac{4}{\rho v d} K_{av} (T - T_0) - g \sin \alpha, \end{cases} \quad (7)$$

where ρ is the density of natural gas; v is the velocity of the gas at the given pipeline point; p is the absolute natural gas pressure at the given pipeline point; λ is the coefficient of hydraulic resistance of the pipeline, a

dimensionless value; α is the angle between the pipe generatrix and the horizontal, radians; K_{av} is the average coefficient of the general heat transfer from gas to environment; T is the natural gas temperature at the given point of a pipeline; T_0 is the gas temperature at the beginning of the pipeline; d is the internal diameter of the pipe; h is the molar gas enthalpy.

Under the condition of the non-stationary processes of gas transportation [16] we applied the equations systems of motion and heat conduction continuity in the following form:

$$\begin{cases} \frac{\partial G}{\partial x} + F \frac{\partial \rho}{\partial t} = 0, \\ \frac{1}{F} \frac{\partial G}{\partial t} - 2v \frac{\partial \rho}{\partial t} + v^2 \frac{\partial \rho}{\partial x} + \frac{\partial p}{\partial t} + gp \frac{\partial H}{\partial x} + \frac{\lambda v |v|}{2d} \rho = 0, \\ F \rho C_p^{spec} \left(\frac{\partial T}{\partial t} + v \frac{\partial T}{\partial x} \right) - F \left(1 + \frac{T}{Z} \left(\frac{\partial Z}{\partial T} \right)_p \right) \frac{\partial p}{\partial t} - \\ - Fv \frac{T}{Z} \left(\frac{\partial Z}{\partial T} \right)_p \frac{\partial p}{\partial x} + Fvg \rho \frac{\partial H}{\partial x} + Q_e = 0, \end{cases}$$

where G is the mass flow rate of gas at the given pipeline point, kg/s; F is the cross-sectional area of the inner tube, m²; H is the height of the given pipeline point above the sea level, m; Z is the natural gas compressibility factor, a dimensionless value; Q_e is the heat flow from gas through the inner surface at time unit per length unit; C_p^{spec} is the specific isobar heat capacity of gas, J/(kg·K).

This system of equations allows problem solving under the conditions of non-stationary operation modes if the change flow of parameters is negligible.

There are developed three schemes of the ship unloading according to the offered layout of the CNG ship and pipeline strapping of the containers system. The first scheme is demonstrated in Figure 7 and it is a typical scheme of the LNG ship unloading. According to this scheme the mooring to the shore communications and docking station are located in the bow of the ship (Figure 1).

This ship unloading scheme has a number of technological constraints and this fact interferes CNG ship unloading in due time (12 hours). Figure 8 demonstrates a diagram of the ship unloading in case of bow mooring but the ship pipeline communications can combine the bow and the stern of the ship. Furthermore, two connection points allow more flexible control of unloading modes (Scheme #2).

As an alternative we examined the scheme of the ship unloading under the conditions of ships mooring to the shore communications and connection of the ship communications in three points (Figure 3). This scheme is demonstrated in Figure 9.

Calculations for unloading process were performed under the following initial conditions:

the absolute pressure of the natural gas in a movable pipeline – 20 MPa;

the absolute temperature of the natural gas in a movable pipeline – 293 K.

The Modules location in blocks is demonstrated in Figure 5. The unloading time is 12 hours; the simulation time is 14 hours (during the first two hours the stationary operation mode of the system is simulated when gas is not picked from a movable pipeline). The internal diameters of the pipe strapping of the movable pipeline are 700 mm. The internal diameter of the pipe that connects the ship with the terminal is 1000 mm.

The mass flow at the unloading point depends on the technical conditions of the gas transmission system to which the CNG ship is connected. There was not chosen compressor and turbine expander equipment for the problem solving outlined in this article. The initial data were specified by the boundary conditions for mass flow in the ship unloading points depending on the circuit connection (in the range of 100 to 290 kg/s). Simulation was performed with a time step of 10 seconds with the defined absolute pressure and temperature in individual container blocks for each circuit connection of the CNG ship.

Figures 10–13 demonstrate a comparative analysis of the absolute pressure and temperature changes in the block of container 2 for each unloading scheme.

The results of calculation showed that the gas pressure and temperature uniformly reduced for all three schemes of CNG Modules unloading in the movable pipeline, indicating a uniform ship unloading. The gas temperature in container blocks of the movable pipeline drops by about 50°C during the unloading time. The pressure drop during unloading for the Schemes #2 and #3 is almost the same, but it is slightly faster than for the Scheme #1. Accordingly, when using the Schemes #2 and #3 the time of container ship loading-unloading will shorten probably in 30 minutes. Due to the fact that the Scheme #3 is more complicated than the Scheme #1 and #2, and the Scheme #1 demonstrates worse loading-unloading results, it is recommended to apply unloading Schemes #2.

For a detailed examination of the pressure change dynamics in a CNG ship we made a diagram of the pressure and temperature dependencies for each block. Figure 14 demonstrates the graphic dependence of the absolute pressure change in a CNG ship for the second unloading scheme for the entire period of simulation.

According to the simulation results it can be noted that the largest difference in absolute pressure and temperature is observed in the block of container #2 and #6 (0.5–0.7 bar for pressure and 0.5°C for temperature). Figure 15–16 demonstrates the results of pressure and temperature simulation in individual container blocks. It should be emphasized that in terms of CNG ships the difference is negligible, generally indicating the even ship unloading.

Conclusions

According to the research results it is offered the scheme of the CNG ship unloading under the conditions of the bow mooring to the port facilities and the presence of the bow and stern containers blocks connections to the pipeline communications.

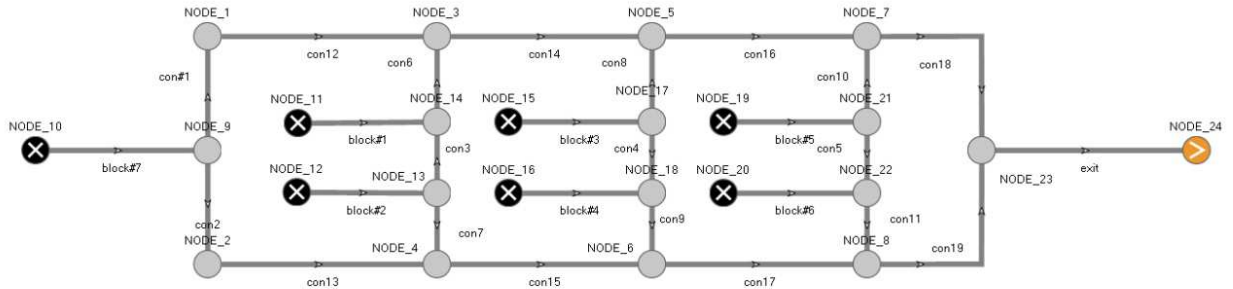

Figure 7 – The scheme of the ship unloading under the conditions of the bow connection of the unloading point

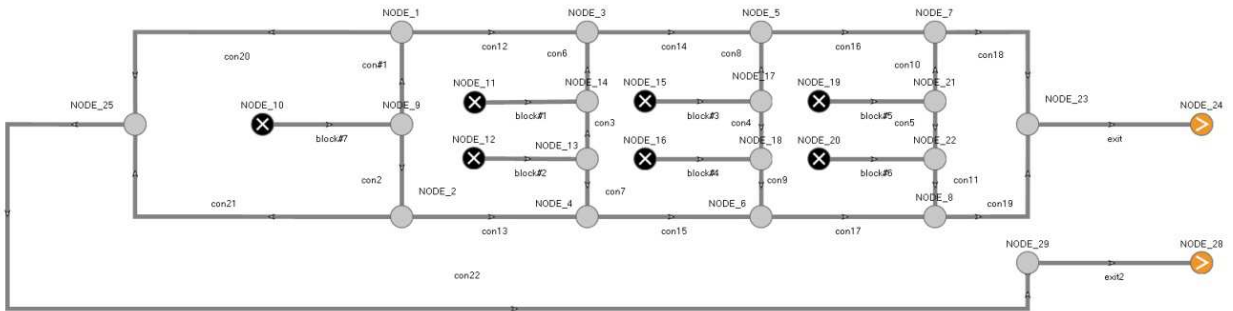

Figure 8 – The scheme of the ship unloading under conditions of the bow connection of an unloading point and the stern connection to an unloading point

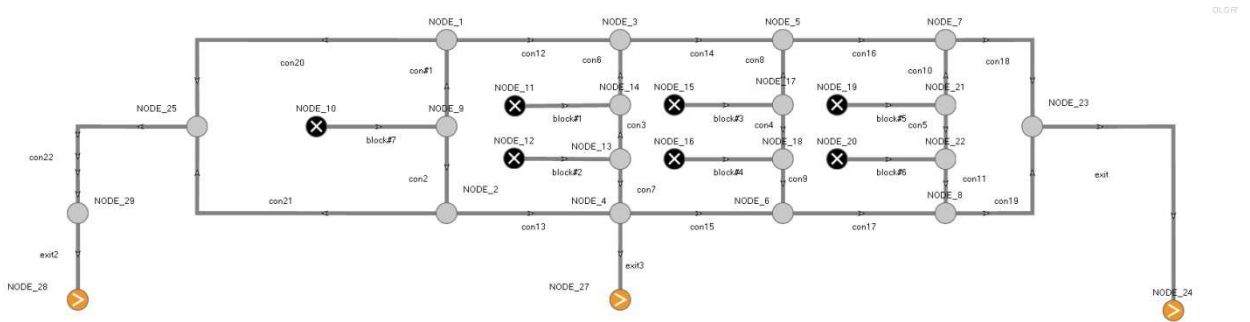

Figure 9 – The scheme of the ship unloading with 3 unloading points

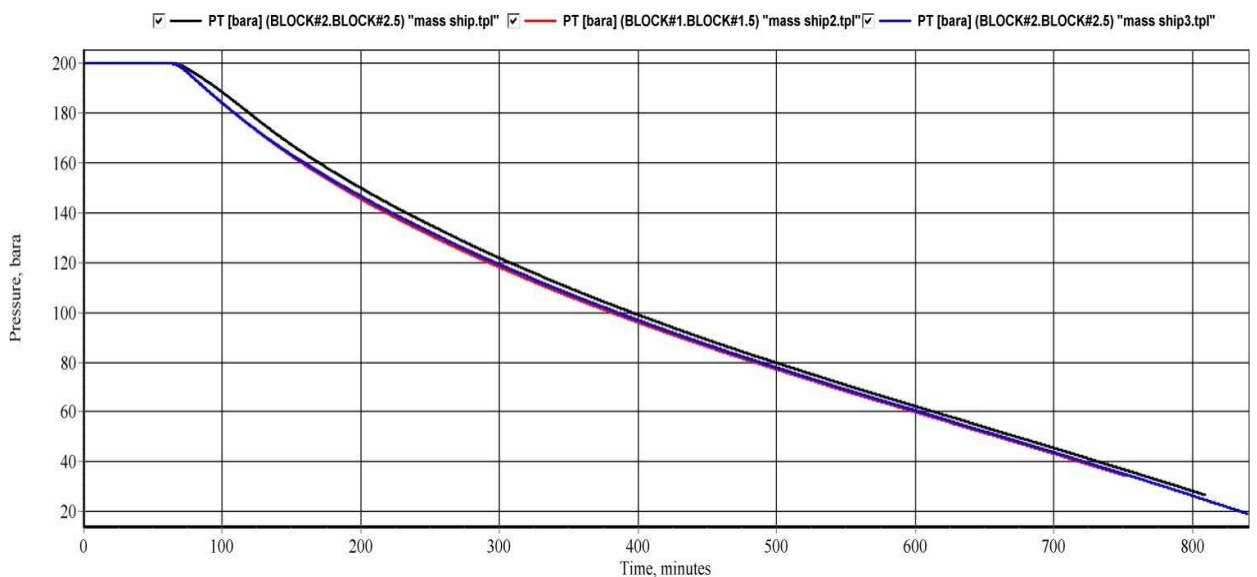

Figure 10 – Dynamics of absolute pressure change in a CNG ship depending on the unloading scheme for the entire simulation period

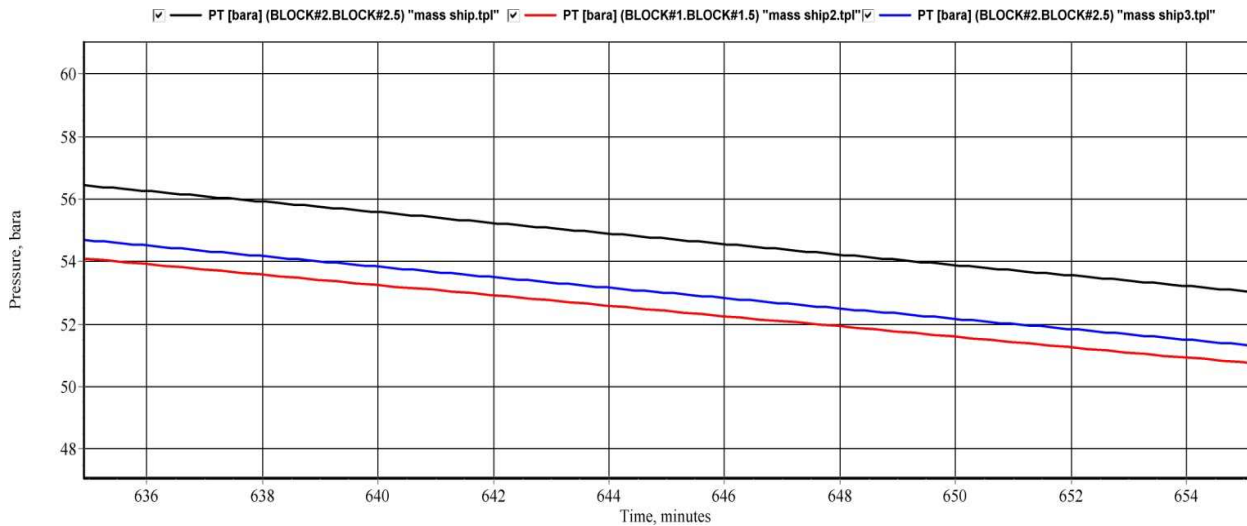

Figure 11 – Dynamics of absolute pressure change in a CNG ship depending on the unloading scheme for the final unloading phase

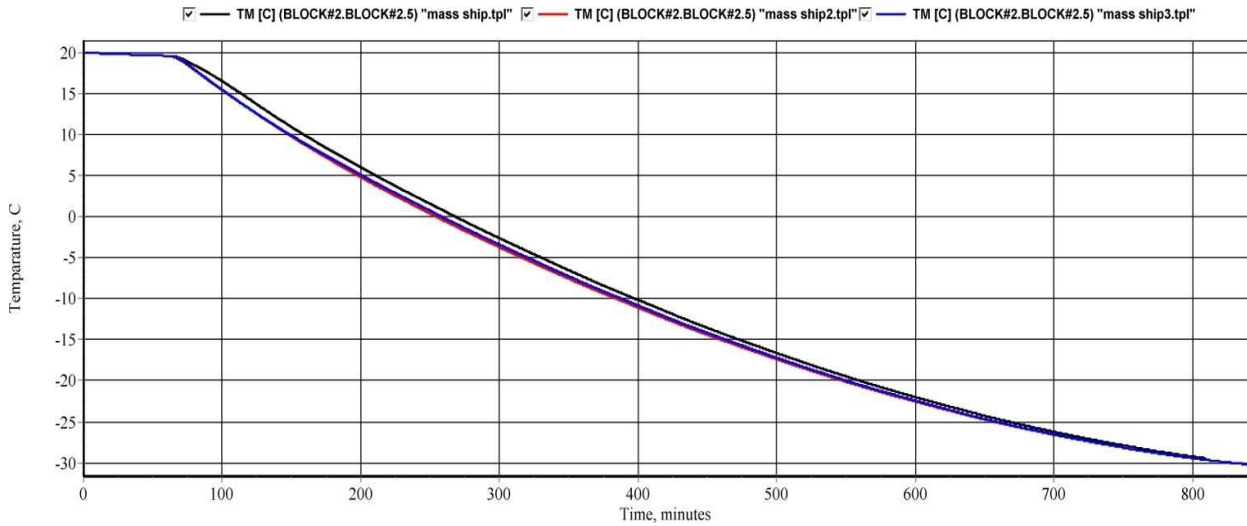

Figure 12 – Dynamics of the temperature change in a CNG ship depending on the unloading scheme for the entire simulation period

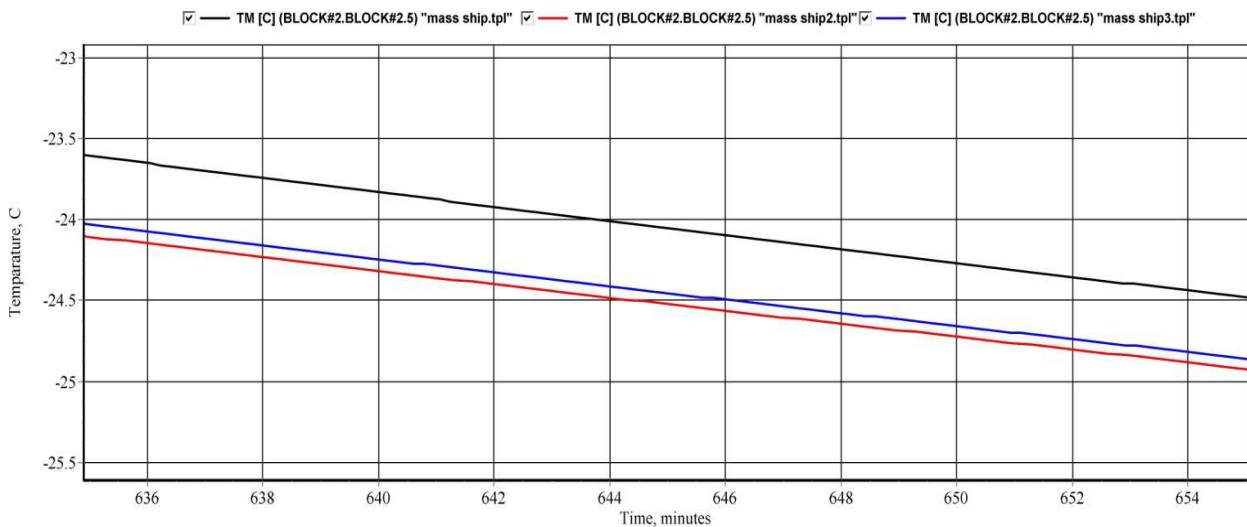

Figure 13 – Dynamics of the temperature change in a CNG ship depending on the unloading scheme for the final unloading phase

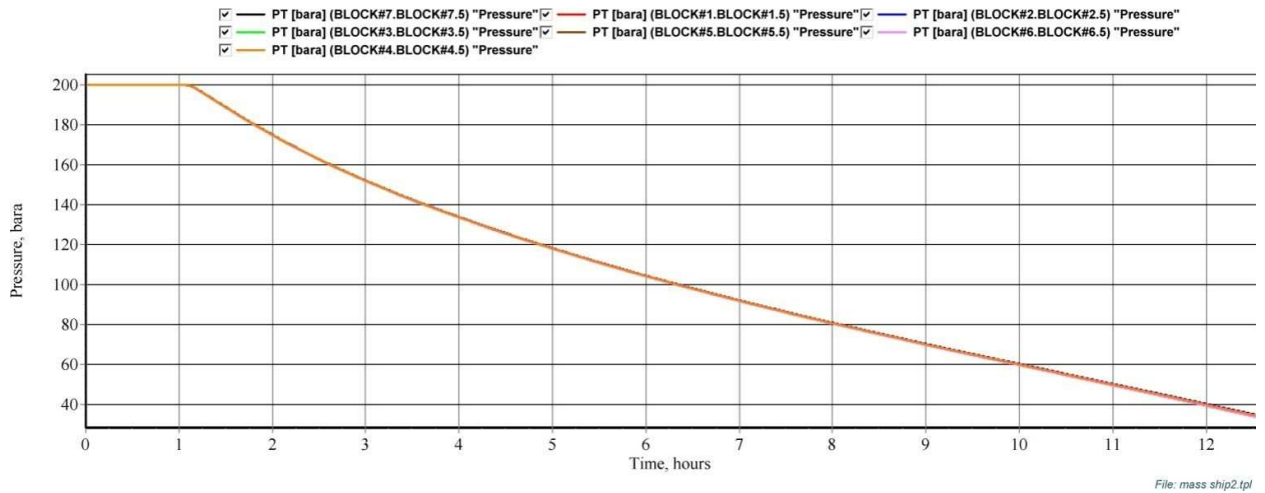

Figure 14 – Dynamics of the absolute pressure change in a CNG ship for the second unloading scheme for the entire period of simulation

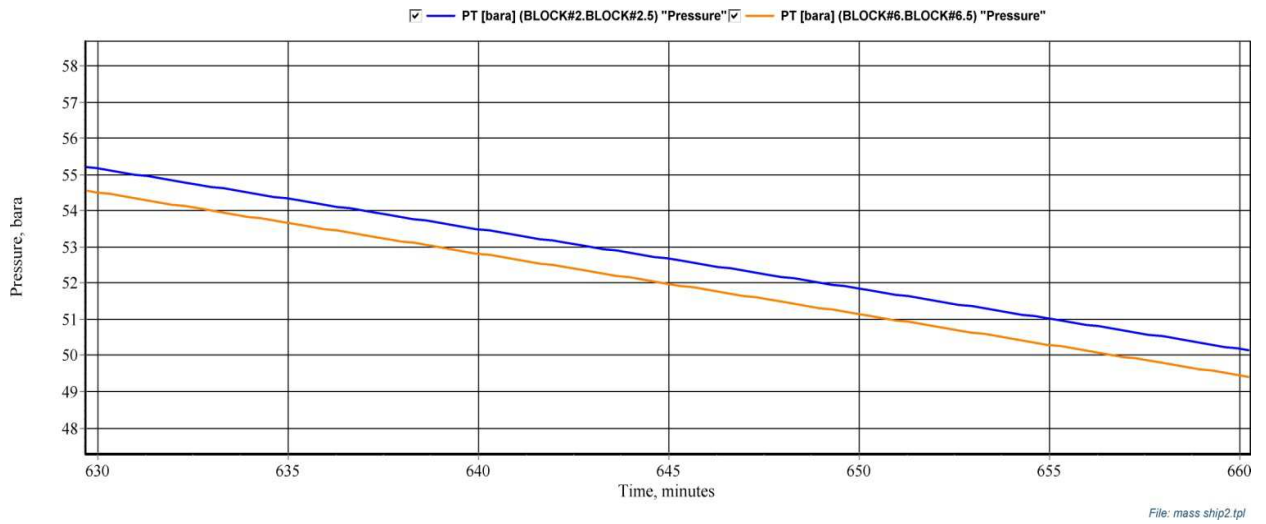

Figure 15 – Dynamics of the absolute pressure change in Block #2 and #6 of the CNG ship for the second unloading scheme for the final period of unloading

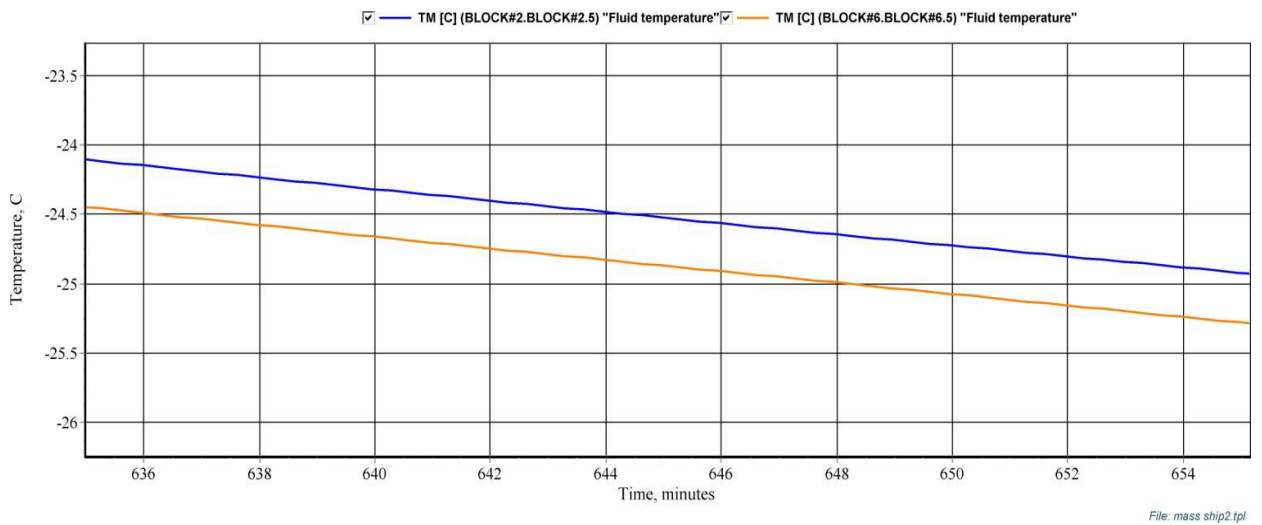

Figure 16 – Dynamics of the temperature change in Block #2 Block and #6 of the CNG ship for the second unloading scheme for the final period of unloading

There are offered two concurrent unloading points with the maximum unloading capacity of 150 kg/s. The further layout of the turbo expander and compressor equipment should result from the offered parameters scheme.

It is proved that the offered pipeline communication scheme provides with the uniform ship unloading (pressure difference in individual containers blocks (0.5–0.7 bar), however, there is a significant uniform (up to -30°C) temperature lowering of the gas due to physical processes of the gas throttling in CNG cylinders. During further research studies it should be considered the impact of the temperature lowering on the mechanical properties of the composite material of the CNG cylinders. Generally, the offered unloading scheme will allow ship unloading in the economically reasonable period of 12 hours.

References

- [1] Kryzhanivskyy, JeI & Zaytsev ValV 2010, 'The concept of fast alternative delivery natural gas to Ukraine', *The 5th International Symposium on hydrocarbons & Chemistry (ISHC5)*, Algiers, pp. 127.
- [2] Paul S. Britton & John P. Dunlop 2007, 'SS: CNG and Other LNG Alternatives—CNG Marine Gas Transport Solution: Tested and Ready', *Offshore Technology Conference*, Houston, Texas, U.S.A., OTC 18702, pp 1-7.
- [3] Yehya Mohamed Ismail Nassar 2010, 'Comparisons and Advantages of Marine CNG Transportation', *SPE Projects, Facilities & Construction*, December, pp. 225-229.
- [4] Matteo Marongiu-Porcu, Xiuli Wang & Michael J. Economides, 2008 'The Economics of Compressed Natural Gas Sea Transport', *SPE Russian Oil & Gas Conference and Exhibition*, Moscow, Russia 28-30 October 2008, SPE 115310 pp. 1-12.
- [5] *CNG Compressed Natural Gas CNG Marine Transport. EnerSea*, 2013. Available from: www.enersea.com. [16 May 2013].
- [6] *Compressed Natural Gas Transportation, CNG Transport. Sea NG*, 2013. Available from: www.coselle.com. [16 May 2013].
- [7] *Trans Ocean Gas CNG Compressed Natural Gas Transportation by Ship*, 2013. Available from: www.transoceanogas.com. [16 May 2013].
- [8] *TransCanada PipeLines Limited*, 2013. Available from: www.transcanada.com. [16 May 2013].
- [9] Kryzhanivskyy, JeI & Zajcev, ValV 2010, 'Konceptija al'ternatyvnogo postachannja pryrodnogo gazu do Ukrainy', *Prospecting and development of oil and gas fields*, no. 4 (37), pp. 5-13.
- [10] Zajcev, VV & Zajcev, ValV 1998, 'Ocenka vozmozhnosti i celesoobraznosti proektirovanija i stroitel'stva sudov – gazovozov sudostroitel'noj promyshlennost'ju Ukrainy', *Collection of scientific works UDMTU*, no. 2(350), pp. 59-68.
- [11] Economides, M, Sun, K & Subero, G 2006, 'Compressed Natural Gas (CNG): An Alternative to Liquefied Natural Gas (LNG)', *SPE Production & Operations*, vol. 21, no. 2, pp. 318-324.
- [12] Mandryk, OM & Zajcev, ValV 2013, 'Vyznachennja tehniko-ekonomichnyh parametriv modulja ruhomogo truboprovodu', *Prospecting and development of oil and gas fields*, no. 1 (46), pp. 179–186.
- [13] Zagoruchenko, VA, Bikchentaj, RN & Vasserman, AA 1980, *Teplotehnicheskie raschety processov transporta i regazifikacii prirodnih gazov. Spravochnoe posobie*, Nedra, Moscow.
- [14] Genick, Bar–Meir 2007, *Fundamentals of Compressible Fluid Mechanics*, Minneapolis, USA.
- [15] Reid, RC, Prausnitz, JM & Poling, BE 1987, *The Properties of Gases and Liquids. 4th ed*, McGraw-Hill.
- [16] Batchelor, GK 2002, *An introduction to fluid dynamics. 12th ed*, Cambridge University Press, Cambridge.

УДК 622.691

Оптимізація режимів розвантаження стиснутого природного газу транспортованого суднами-контейнеровозами

Є.І. Крижанівський, О.М. Сусак, Вал.В. Зайцев

*Івано-Франківський національний технічний університет нафти і газу;
вул. Карпатська, 15, м. Івано-Франківськ, 76019, Україна*

Метою дослідження є розрахунок параметрів вивантаження судна «рухомого трубопроводу», як частини вантажного плану CNG судна, розроблення технологічної схеми обв'язки блоків контейнерів CNG судна, розробка схеми вивантаження CNG судна за умов різних схем швартування, розрахунок параметрів потоку газу в процесі вивантаження.

Наукова новизна роботи полягає в обґрунтуванні технологічної обв'язки блоків контейнерів з метою рівномірного завантаження/розвантаження CNG судна, визначення необхідної продуктивності точок вивантаження з метою забезпечення тривалості вивантаження не більше 12 год.

За результатами досліджень пропонується схема вивантаження CNG судна за умов носового швартування до портових споруд і наявності носового та кормового з'єднання блоків контейнерів до трубопровідних комунікацій.

Пропонуються дві паралельні точки розвантаження із максимальною продуктивністю 150 кг/с. Подальша компоновка турбодетандерного та компресорного обладнання повинна виходити із запропонованої схеми параметрів.

Доведено, що для запропонованої схеми трубопровідних комунікацій та продуктивності двох паралельних точок вивантаження спостерігається рівномірне вивантаження судна (різниця тисків по окремих блоках контейнерів (0.5–0.7 бар), проте, за рахунок фізичних процесів дроселювання газу в CNG балонах, спостерігається суттєве рівномірне (до мінус 30 °C) зниження температури газу. У подальших дослідженнях потрібно розглянути вплив зниження температури на механічні властивості композитного матеріалу CNG балонів. Загалом запропонована схема вивантаження дасть змогу здійснювати операції з розвантаження судна за економічно обґрунтований період часу в 12 годин.

Одержані результати можна використовувати для подальшого розроблення технологічної схеми наземного обладнання для підключення CNG судна, підбору технологічного обладнання, оцінки впливу параметрів потоку газу на механічні властивості металу труб і композитного матеріалу.

Ключові слова: CNG балони, CNG судно, CNG транспорт.