

Numerical prediction of the current and limiting states of pipelines with detected flaws of corrosion wall thinning

O. S. Milenin*

*Paton Electric Welding Institute of NAS of Ukraine;
11, K. Malevych Str., Kyiv -150, 03680, Ukraine*

Received: 14.06.2017 Accepted: 10.07.2017

Abstract

The main assumptions have been made for the physical and mathematical models of combined development of the stress-strain state and voids of ductile fracture in welded pipeline elements and pressure vessels with the detected 3D metal discontinuities (local corrosion losses of metal, macrovoids), including the ones located in the area of site welds for determination of the characteristic features of defective structures' limiting state. Analysis of the stress-strain state of the welded pipeline section has been carried out based on finite element solution of the problem of non-stationary thermoplasticity by tracing elastic-plastic deformations from the beginning of welding to the complete cooling of the structure and subsequent loading to the limiting state. The continuum dilatation model of fracture is based on a stepwise prediction of micro- and macro-damage of material both in welding and under loading with internal pressure and external force bending moment to the limiting state on the basis of the Gurson–Tvergaard–Needleman theory. The criteria for macroscopic fracture of structure on a brittle-ductile mechanism have been proposed.

Methods for probabilistic estimation of the stressed state of the pipeline structure from the point of view of fracture susceptibility, which are based on the integration of the calculated field of principal stresses within the framework of the Weibull statistics, have been developed. Functional dependences of Weibull coefficients on the properties of the metal, namely yield stress and degree of strain hardening, were obtained for correct quantitative assessment of the state of critical structures based on a complex analysis of the limiting state of steel pipelines under internal pressure.

Specific features of the limiting state under loading with internal pressure and bending moment have been investigated based on an example of typical cases of operation damage of main pipeline elements such as local metal losses in the area of the site weld. It was shown that nature of interaction of residual post-weld stress state of metal with operation stresses from the geometry concentrator significantly affected the value of limiting pressure in the pipe. Besides, effect of the additional bending moment on load-bearing capacity of the pipeline section with isolated flaw of local corrosion wall thinning has been determined. The change of failure probability of the structure as a result of internal pressure and bending moment loading at various geometry dimensions of thinning flaw has been investigated based on the results of integral analysis of the pipeline flawed section state.

Keywords: 3D discontinuity flaws, ductile fracture, failure probability, limiting state, mathematical modeling, the stress-strain state, welded pipeline.

Analysis of the static strength and working capacity of pipeline elements with detected operational flaws is most often based on the determination of the limiting state of the structure, based on a certain system of loads and characteristics of the material resistance to various types of fracture. Multifactority of the boundary state of real structures and the complexity of processes of origin and development of fracture lead to a significant increase in the conservatism of corresponding engineering techniques and formulation of inefficient, from an economic point of view, expert conclusions based on the results of technical diagnosis of industrial objects [1–3]. The use of the latest theoretical developments in the field of prediction of

materials and structures strength, along with the possibilities of modern means of numerical computing of physical processes, is one of the important approaches that allows to take into account a sufficiently wide range of characteristics of the actual state of the investigated structure and reasonably reduce the conservatism of the corresponding estimates. In particular, with regard to the elements of the main and technological pipelines, one of the ways of constructing a similar methodology is to take into account the features of assembly or repair welding at the state of the metal structure, including, if the welds of operational flaws of corrosive nature appear on the periphery [4]. To do this, it is necessary to create a method for predicting the residual state of the structure after the site welding, as well as the development of appropriate criteria for the limiting state. In case of the absence of sharp stress concentrators, the nucleation prediction and development of fracture of the metal pipe elements occurs by the ductile mechanism, i.e. the formation of uniformly distributed micro voids during plastic strain

* Corresponding author:
asmilenin@ukr.net

of the metal. Subcritical damage, which precedes the formation of a macro flaw, is mutually connected with the stress-strain state of the structure, that is why the implementation of techniques of numerical prediction of the static strength requires the development of appropriate complex models that take into account the relevant characteristics of the material resistance to the ductile and brittle-ductile fractures. One of the rational methods for assessing the current state of structure and its working capacity is the integral probabilistic analysis as a necessary component of the risk analysis of industrial systems. Based on the calculated limiting state of pipeline elements with detected flaws it is possible to build appropriate probabilistic methods that allow quantifying the susceptibility to fracture of the welded pipeline element during complex operational loads.

The current trend in the development of methodological approaches to the analysis of the current state of structures is to reduce the conservatism of expert conclusions both for substantiation of out-of-project exploitation and determining the admissibility of detected processes of flaws technical diagnostics. To do this, there are proposed complex methods for subcritical and critical states of critical structures under different load conditions: static, variable static, fatigue, temperature-force, etc. based on modern ideas about the development of physical and mechanical processes. In particular, a number of practically important studies are devoted to the prediction of ductile fracture of structure materials, and it is a phenomenon characteristic of typical pipelines and pressure vessels in the absence of sharp geometric concentrators [5–7]. But a limited number of works is devoted to typical problems of simulating subcritical fracture of critical welded structures, despite the fact that most of such structures have sections of assembly or repair welding, characterized by lower resistance to fracture [8, 9].

The main disadvantage of existing methods for assessing the working capacity of critical welded structures, in particular, pipeline elements, is a significant simplification of the analysis of the metal state in the welding place in the absence of sharp geometric concentrators. This is due to the complexity of prediction of the residual stress-strain state of metal in the area of a permanent connection, depending on the technological modes of assembly or repair welding (post weld heat treatment), and the sub-critical damage to metal, which determines the limiting state of the considered structure. In addition, the complex distribution of stresses in the section of the welded structure complicates the analysis of the static and long-term strength of the structure element, especially in the presence of additional geometric concentrators, such as flaws of the local corrosion loss of metal, as it requires the use of integral criteria of the boundary state.

The main purpose of this work is to build complex numerical methods and means of predicting the joint development of stress-strain and damaged states of the welded structures, the study of the features of the limiting state, static strength and operability of the piping systems welded elements with operating flaws in local corrosion loss of metal.

For the analysis of kinetics of physical, structural and thermomechanical processes during welding and subsequent operation of welded structures it is expedient to use methods of mathematical modeling on the basis of proven means of numerical and computer implementation of spatial kinetic models. Thus, the temperature field during welding is determined by the thermal effect of a moving surface welding heat source. The energy of welding heating, most often, is distributed according to the circular normal law. It is assumed that the heat transfer in the sample to be welded is caused by conductive processes, described by the solution of the non-stationary heat equation (1). The flow of heat into the environment (technological equipment and atmosphere), with the temperature T_e , is taken into account by formulating the corresponding boundary conditions under Newton's and the Stefan-Boltzmann laws (2) [10]:

$$c\gamma(r, \varphi, z, T) \frac{\partial T(r, \varphi, z)}{\partial t} = \nabla [\lambda(r, \varphi, z, T) \nabla T(r, \varphi, z)]; \quad (1)$$

$$-\lambda \frac{\partial T}{\partial n} = \alpha_T (T - T_e) + \varepsilon_{SB} \sigma_{SB} (T^4 - T_e^4), \quad (2)$$

where T , λ , $c\gamma$ are the temperature, heat conductivity and volumetric heat capacity of the structure material at a given point, respectively; n is the normal to the surface; α_T is the coefficient of heat transfer; ε_{SB} is the emissivity coefficient of the structure surface; σ_{SB} is the Stefan-Boltzmann constant.

Taking into account the peculiarities of physical processes during melting of metal, the temperature dependences of heat conductivity and heat capacity are described as follows:

$$c\gamma(T) = \begin{cases} c\gamma(T_S) + \frac{g_{lh}}{T_L - T_S}, & T_S < T < T_L; \\ c\gamma(T_L), & T \geq T_L; \end{cases} \quad (3)$$

$$\lambda(T) = \begin{cases} \lambda(T), & T_S < T < T_L; \\ \lambda(T_L) n_c, & T \geq T_L; \end{cases} \quad (4)$$

where T_L , T_S are the liquidus and solidus temperatures, respectively; g_{lh} is the latent heat of melting, $n_c \geq 3-5$ is the coefficient allowing to take into account convective heat transfer in a liquid metal of a weld pool.

The estimated kinetics of the temperature field allows to implement the numerical tracing of the development of stress-strain and damaged states of structure material both during welding and subsequent exploitation. In the absence of sharp stress concentrators, the nucleation and development of subcritical damage to the pipeline element is determined by a ductile mechanism, which can be represented by the successive stages given in Fig. 1. Each of these stages has a different physical and mechanical nature, and therefore their description requires the development of relevant interconnected models. Thus, the nucleation of voids of ductile fracture is determined by the development of the plastic flow of the metal in both the isothermal and non-isothermal cases. Therefore, as a criterion for the nucleation of micro voids of a certain concentration f_0 there was chosen a modified Johnson-

Cook approach that offers the following condition for the nucleation of damage [11]:

$$\int \frac{d\varepsilon_i^p}{\varepsilon_c} > 1, \quad (5)$$

where $d\varepsilon_i^p = \frac{\sqrt{2}}{3} \cdot \sqrt{d\varepsilon_{ij}^p \cdot d\varepsilon_{ij}^p}$; $d\varepsilon_{ij}^p$ are the components of the tensor of plastic strains; ε_c is the critical value of plastic strains.

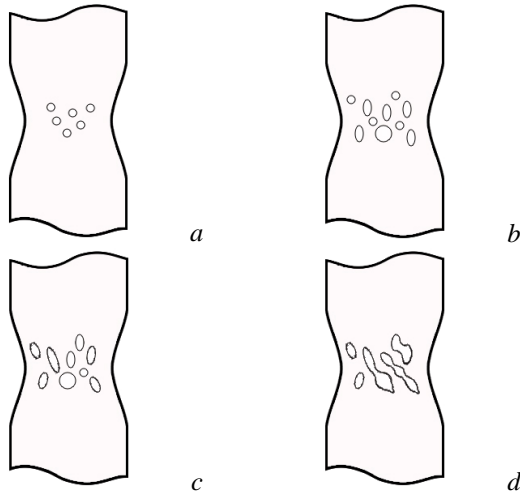

a – the nucleation of primary microvoids; b – the growth of voids during ductile deformation and the nucleation of secondary microvoids; c – the nucleation of a macroflaw; d – the growth of a macroflaw

Figure 1 – The scheme of the stages of the ductile fracture development

Usually the critical deformation ε_c depends on the characteristics of the metal, its temperature and the stiffness of the stressed state (the ratio of membrane stresses to the intensity of stresses σ_m/σ_i). Therefore, the value of this parameter can be estimated according to the following ratio:

$$\varepsilon_c = \left(d_1 + d_2 \exp \left\{ -d_3 \frac{\sigma_m}{\sigma_i} \right\} \right) \exp \left\{ \left[\frac{\sigma_Y - \sigma_Y(T)}{B_f} \right]^\zeta \right\}, \quad (6)$$

where $d_1, d_2, d_3, B_f = (1.0 \dots 1.5) \sigma_Y, \zeta \approx 3$ are the constants; σ_Y is the yield strength.

It should be noted that the appearance of uniformly distributed voids in the metal of welded joints according to the mechanism of ductile fracture according to (5)–(6) corresponds to the deformation mechanism of nucleation, but the crystallization of gas bubbles and metal shrinkage are the alternative ways of voids occurrence. Simulation of the formation of bubbles in a weld pool that do not have time to stand out in the gas phase before crystallization of the metal is rather complicated and it is not within the scope of this work, but this effect can be taken into account as a predetermined concentration of micro voids f_{g0} in the metal of the seam. Additionally, the influence of the internal pressure of the P_{void} diffusion gases, accumulated in voids, is taken into account based on the change in pore volume from elastic deformation:

$$f_g = f_{g0} \left[1 + \frac{3(1-\nu)}{4\pi E} P_{void} \right], \quad (7)$$

where E is Young's modulus; ν is Poisson's ratio.

The formation of shrinkage voids in the solid-liquid state of the metal is due to the specificity of the crystallization processes, namely, the closure of the crystalline alloy frame with the residual volume of the fusible eutectic V_r , which can cause some void fraction after further cooling and shrinkage. The volumetric concentration of shrinkage voids depends on the temperature cycle during welding, in particular, from the maximum heating temperature T_{max} of a particular part of a structure. So, if the metal heats up above the closing temperature of the crystal lattice T_r , the volume of shrinkage voids is determined according to the following ratio:

$$f_u = \frac{\rho_s - \rho_l}{\rho_s} V_r, T_{max} \geq T_r, \quad (8)$$

where ρ_s, ρ_l is the metal density in the solid and liquid phase respectively.

When cooling the metal at maximum temperatures below T_r , the volume concentration of the acquired shrinkage porosity depends on the actual volume of the liquid phase V_l :

$$df = \frac{\rho_s - \rho_l}{\rho_s} V_l, T_S < T_{max} < T_r. \quad (9)$$

The volume of the liquid phase in this case is determined by the temperature cycle and the properties of the material according to the lever rule:

$$V_l = \frac{T_{max} - T_S}{T_L - T_S}, T_S < T_{max} < T_r. \quad (10)$$

The connection between the residual volume of fusible eutectics and the closing temperature of the crystal lattice has the following mathematical expression:

$$T_r = T_S + (T_L - T_S) V_r. \quad (11)$$

Thus, in the process of welding there can be distinguished between different zones that determine the volume and nature of distribution of the scattered damage, depending on the nature of distribution of temperatures and characteristics of the metal of the welded structure. The presence of metal discontinuity has an effect on the development of the stress-strain state of the metal structure under the influence of the external force. One of the recognized approaches, which allow taking this factor into account, is the use of various continual approaches with modifying the material's yield surface, depending on the volume concentration of uniformly distributed discontinuity. In particular, the Gurson–Tvergaard–Nidلمان approach is the most used. According to it, the yield surface is described as [12, 13]:

$$\Phi = \left(\frac{\sigma_i}{\sigma_Y} \right)^2 - (q_3 f')^2 + 2q_1 f' \cosh \left(q_2 \frac{3\sigma_m}{2\sigma_Y} \right) - 1, \quad (12)$$

where q_1, q_2, q_3 are the constants; f' is the equivalent concentration of voids.

The value of the equivalent concentration of voids appearing in (12) is determined as follows:

$$f' = \begin{cases} f, & \text{if } f \leq f_c \\ f_c + \frac{f_w - f_c}{f_F - f_c} (f - f_c), & \text{if } f > f_c \end{cases} \quad (13)$$

where f_c is the critical value of discontinuity concentration, to which individual voids do not interact, and it is assumed to be equal to 0.15; f_F is the concentration of voids, at which the fracture of a finite element occurs; $f_w = 1/q_1$.

It should be noted that the limiting transition $f' \rightarrow 0$ transforms the conditions of the plastic flow (12) into the Mises criterion, therefore this should be taken into account when designing the continuum models of the stress-strain state of the structure with the partial tendency of individual parts to ductile fracture, in particular, during welding.

The further growth of originated voids depends on the stiffness of the stressed state and the intensity of the plastic deformation of metal and is described by Rice–Tracy's law, namely [14]:

$$dR = R_0 K_1 \exp\left(K_2 \frac{\sigma_m}{\sigma_i}\right) d\varepsilon_i^p, \quad (14)$$

where R , R_0 is the current and initial void's radius respectively; σ_i is the intensity of stresses; $K_1 = 0.28$, $K_2 = 1.5$ are the constants.

In the case where the stiffness parameter of the stress state of the structure's section under consideration is small for the intensive growth of the voids according to (14), then the substantial development of plastic deformations can lead to the appearance of secondary imperfections. The rate of nucleation of secondary spherical voids depends on the concentration of inclusions in the metal of the structure and the development of plastic deformations according to the following law:

$$f = f_0 + f_i \exp\left(-\frac{\kappa'}{\kappa - \kappa_c}\right), \quad (15)$$

where f_i is a volumetric concentration of inclusions; κ' is a constant characterizing the maximal possible increase of the Odquist parameter κ .

It should be noted that the value f_i depends on the structural state of the metal in the weld's section and the heat affected zone (HAZ), as well as initial non-metallic inclusions and those acquired in the process of welding.

The study of the combined problem of the kinetics of the temperature field, the development of stresses and strains, and the formation of microvoids is based on a corresponding finite element description using eight-node finite elements (FEs) based on the WeldPrediction software complex. Within the volume of a particular element, the distribution of temperatures, stresses and strains is assumed to be homogeneous. The growth of the strain tensor (taking into account the presence and uniform distribution of microvoids) can be represented by the following expression [15]:

$$d\varepsilon_{ij} = d\varepsilon_{ij}^e + d\varepsilon_{ij}^p + \delta_{ij} (d\varepsilon_T + df/3), \quad (16)$$

where $d\varepsilon_{ij}^e$, $d\varepsilon_{ij}^p$, $\delta_{ij} \cdot d\varepsilon_T$, $\delta_{ij} \cdot df/3$ are the components of the growth of the strain tensor due to the elastic strain mechanism, plastic strains, the kinetics of the inhomogeneous temperature field and porosity, respectively $i, j = r, \beta, z$ (Fig. 2).

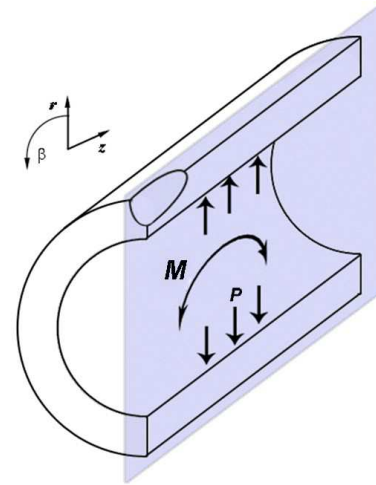

Figure 2 – The scheme of the system of external loads (bending moment M and internal pressure P) acting on the defective element of the pipeline

Dependence of strains on stresses is determined by Hooke's law and the associated law of the plastic flow, based on the following relation:

$$\Delta\varepsilon_{ij} = \Psi (\sigma_{ij} - \delta_{ij} \sigma_m) + \delta_{ij} (K \sigma_m + \Delta\varepsilon_T + \Delta f/3) - \frac{1}{2G} (\sigma_{ij} - \delta_{ij} \sigma_m)^* + (K \sigma_m)^*, \quad (17)$$

where δ_{ij} is the Kronecker symbol, that is, $\delta_{ij} = 1$ if $i = j$ and $\delta_{ij} = 0$ if $i \neq j$, σ_m is the average value of the normal components of the stress tensor σ_{ij} ; $K = (1 - 2\nu)/E$ is the module of volumetric compression; $G = 0.5E/(1 + \nu)$ is the shear modulus; the symbol «*» refers the variable to the previous tracing step; Ψ is a function of the material state that determines the condition of the plastic flow in accordance with the von Mises criterion, with the additional consideration of reduction of the bearing net cross section of the finite element as a result of the formation of discontinuity within the framework of the Gurson–Tvergaard model.

The implementation of numerical tracing is associated with two nonlinearities in physical processes: plastic strain and fracture. There were applied corresponding iterative processes that allow us to find the state of a finite element satisfying the equilibrium equation and the condition of the plastic flow to solve these nonlinear problems. To solve the nonlinearity in plastic strain there was applied an approach proposed by V. I. Makhnenko, namely, the consideration of the function of the state of a material Ψ satisfying the following conditions on the yield surface [16]:

$$\Psi = \frac{1}{2G}, \text{ if } \sigma_i < \sigma_s = \sigma_Y \sqrt{1 + (q_3 f')^2 - 2q_1 f' \cosh\left(q_2 \frac{3\sigma_m}{2\sigma_Y}\right)};$$

$$\Psi > \frac{1}{2G}, \text{ if } \sigma_i = \sigma_s; \tag{18}$$

state $\sigma_i > \sigma_s$ is invalid.

The main difficulty in tracing the non-stationary load, in particular, the cyclic one, is that small changes in the state of metal, namely, the accumulation and growth of subcritical damage, cause a change in the yield surface in accordance with (12) and the evolution of a plastic strain loop. But at the same time it is necessary to determine the equilibrium state of the damage and the corresponding distribution of stresses and strains at each step of tracing. To do this, it is offered to carry out the following iteration process on the function Ψ_k from the assumption that the stationary state is characterized by a negligibly low rate of the volume growth of ductile fracture voids in (14)–(15):

$$F = \begin{cases} F + dF, & \text{if } f_0 K_1 \exp\left(K_2 \frac{\sigma_m}{\sigma_i}\right) d\varepsilon_i^p = \\ & = \Psi_k \leq \Psi_k^0 \approx 10^{-5}; \\ F, & \text{if } \Psi_k > \Psi_k^0, \end{cases} \tag{19}$$

where F is a system of external power loads upon the structure; dF is an increment of power load during numerical tracing.

As a criterion for the nucleation of macroscopic fracture, the condition of brittle-ductile fracture was used, namely the fulfillment of one of three conditions:

$$\left(\Psi - \frac{1}{2G}\right)_{cr} \geq \frac{\varepsilon_f - \varepsilon_p^*}{1.5\sigma_i} \approx \frac{\varepsilon_f - \varepsilon_p^*}{1.5\sigma_s(\varepsilon_p, T)};$$

$$f' = \frac{1}{q_1} \exp\left(-\frac{3q_2 \sigma_m}{2 \cdot \sigma_T}\right); \tag{20}$$

$$\frac{\sigma_1}{1 - 2f/3} > S_K,$$

where S_K is the tension of the microcircuit value; ε_f is the limiting strain ability of material.

It is known that metal behavior varies considerably depending on the size of its strain: in case of relatively small strains, the material is elastic and strains are reversible after removal of the external load; when the stresses of plastic flow of metal are formed, irreversible plastic strains are formed; further material loading causes some kind of strengthening as a result of cold-hardening. The shape of Mises yield surface, depending on the intensity of accumulated plastic strains, is considered in the following form:

$$\sigma_Y = \sigma_Y^0 \left[1 + c_1 \ln\left(\frac{\dot{\varepsilon}_p}{\dot{\varepsilon}_0}\right) + c_2 \left\{ \ln\left(\frac{\dot{\varepsilon}_p}{\dot{\varepsilon}_0}\right) \right\}^2 \right] \left[1 + \left(\frac{\varepsilon_p}{\varepsilon_0}\right)^m \right], \tag{21}$$

where $c_1=2.149 \cdot 10^{-3}$; $c_2=9.112 \cdot 10^{-2}$; $\varepsilon_0=1.540 \cdot 10^{-4}$; $m=0.14$ are the constants; the point over the variable

marks the time differentiation; σ_Y^0 is the initial value of the yield stress.

Accordingly, metal of the structure changes its properties as a result of cold-hardening in the process of accumulation of plastic strains while the tendency to strain strengthening, quantitatively characterized by constants in equation (21), determines the degree of development of the fracture of a particular type. This phenomenon is important for the formation of new alloys for welded pipelines, as well as for the development of specific design solutions for individual pipeline elements.

The implementation of conditions (18)–(19) is performed at each step of tracing by the iterative method, taking into account the corresponding dependence σ_s on temperature, damage and history of the plastic strain. At the same time, the stresses σ_{ij} are calculated as follows (a summation occurs by the duplicate indices) at each step of the iteration of Ψ and Ψ_k [16, 17]:

$$\sigma_{ij} = \frac{1}{\Psi} \left(\Delta\varepsilon_{ij} + \delta_{ij} \frac{\Psi - K}{K} \Delta\varepsilon \right) + J_{ij}, \tag{22}$$

where $\Delta\varepsilon = \frac{\Delta\varepsilon_{ii}}{3},$

$$J_{ij} = \frac{1}{\Psi} \left[(b_{ij} - \delta_{ij} b) + \delta_{ij} \left(K \sigma^* - \frac{\Delta\varepsilon_T + \Delta f/3}{K} \right) \right],$$

$$b = \frac{b_{ii}}{3}.$$

The relation between the components of the strain tensor $\Delta\varepsilon_{ij}$ and the vector of displacement increment ΔU_i has the following mathematical expression:

$$\Delta\varepsilon_{ij} = \frac{\Delta U_{i,j} + \Delta U_{j,i}}{2}, \tag{23}$$

where a comma marks the differentiation within the FEs.

The components of the stress tensor satisfy the statics equation for internal FEs and the boundary conditions for the superficial ones. In their turn, the components of the vector $\Delta U_i=(\Delta U_i, \Delta V_i, \Delta W_i)$ satisfy the corresponding conditions at the boundary. The solving system of algebraic equations in the variables of the displacement increment vector in the nodes of the FEs at each step of tracing and iterations by Ψ is determined by minimizing the following functional (Lagrange variational principle):

$$L_l = -\frac{1}{2} \sum_V (\sigma_{ij} + J_{ij}) \Delta\varepsilon_{ij} V_{k,l,r} + \sum_{S_p} F_i \Delta U_i \Delta S_P^{k,l,r}, \tag{24}$$

where \sum_V is the operator of the sum by the internal FEs; \sum_{S_p} is the operator of the sum by the surface FEs,

in which the components of the force vector F_i are given, that is, the following system of equations allows us to obtain a solution in the components of the displacement increment vector at each tracing step and iterations by Ψ (Ψ_k) for a specific FEs:

Table 1 – Comparison of results of numerical calculations of the ultimate pressure in flawed pipeline elements with the data of laboratory tests [18]

Wall thickness, mm	Internal radius of a pipe, mm	Depth of a flaw, mm	Length of a flaw, mm	Width of a flaw, mm	Fracture pressure, MPa	Design pressure of fracture, MPa	Error, %
3.1750	69.596	1.6002	38.1508	9.525	10.5494	10.5	0.47
3.2512	69.596	1.6764	38.0492	38.0492	13.1695	11.9	9.64
2.8448	70.104	0.5080	40.2336	10.1092	14.8243	14.5	2.19
2.8448	68.580	2.0066	38.2016	10.0076	7.23975	7.3	0.83
3.1496	65.786	2.4130	12.1412	3.9878	14.4795	13.2	8.84
3.1242	65.786	2.5400	6.1214	9.652	15.6861	16.6	5.83
3.1242	65.786	2.2606	59.6392	10.2616	6.5503	6.5	0.77
3.1496	65.786	2.3876	12.319	363.499	8.9635	9.4	4.87
6.2992	66.548	5.3594	53.4924	9.8298	11.7215	11.6	1.04
6.2484	66.548	4.6990	13.7668	9.779	22.7535	24.1	5.92

$$\frac{\partial L_I}{\partial \Delta U_{k,l,r}} = 0, \frac{\partial L_I}{\partial \Delta V_{k,l,r}} = 0, \frac{\partial L_I}{\partial \Delta W_{k,l,r}} = 0. \quad (25)$$

The validation procedure of the developed model of nucleation and growth of ductile fracture voids, as the main mechanism determining the limiting state of a pipeline element with a flaw of wall thinning, consists in comparing the limiting pressure P_{max} and the degree of reduction of the bearing capacity of model thick-walled tubes with external flaws of various sizes, obtained during a numerical study, with the available experimental data [18]. As it is shown in Table 1, the accuracy of calculated results of determining the boundary pressure is satisfactory: the error does not exceed 10 %.

The probability of fracture of a flawed structure has a double nature: the uncertainty is determined by the inaccuracy of the available data or the stochastic nature of the actual failure process. Depending on the purpose of study and the type of the structure damage, there may be applied various approaches of probabilistic analysis. If the geometry of the studied structure does not have sharp concentrators, the following approach to determining the probability of fracture can be used: a probabilistic estimation is implemented by integrating the field of main stresses within the Weibull statistics for the description of the fracture by the mechanism of the "weak link". In this case, it is assumed that the probability of fracture can be described by the three-parameter Weibull function within the FEs [19]:

$$p_i = 1 - \exp \left[- \left(\frac{\sigma_1 - A}{B} \right)^\eta \right], (\sigma_1 > A), \quad (26)$$

where A, B, η are Weibull parameters.

Integration of the stresses field over the area of the weakest cross section S allows us to estimate the integral probability of the structure failure:

$$p = 1 - \exp \left[- \int_S \left(\frac{\sigma_1 - A}{B} \right)^\eta \frac{dS}{S_0} \right], (\sigma_1 > A), \quad (27)$$

where S_0 is the constant characterizing the spatial scale of the transition of micro-damage to the macroflaw.

The accuracy of the quantitative probabilistic estimate according to (27) depends on the adequacy of the values of the Weibull parameters used to the specific problem. The determination of the values of A, B and η may be based on either a series of experimental studies on the failure of samples using identical materials and a similar load system, and the subsequent statistical analysis of the results obtained, or on numerical studies of a limiting state of the structure, taking into account the results of technical diagnostics. The second approach is less labor-intensive, but more conservative in terms of application of numerical methods for analyzing stress-strain and boundary states of a flawed structure, taking into account the development of various flaws.

Coefficient A in (26)–(27) characterizes the possibility of the FEs failure at relatively low stresses. In theory, there is a nonzero probability of the fracture nucleation at stresses close to zero ($A = 0$), but this approach is not rational for the solution of applied problems. To reduce the complexity of the numerical study, it is assumed that the probabilistic nature of the failure is observed in stresses that exceed the value of the plastic flow σ_{flow} , which depends on the strength properties of a particular material, namely $\sigma_{flow} = (\sigma_U + \sigma_Y)/2$, where σ_U is the ultimate stress. In its turn, the value of η for describing the failure of structure steels is assumed to be equal to 3–4. Thus, the purpose of the analysis of stress fields in the structure in the limiting state is to determine the parameter B in the Weibull distribution, which will allow us to carry out the necessary quantitative estimates of the probability of an emergency situation of the pipeline flawed section.

An integrated methodology for numerical analysis allow us to study a class of practically important tasks of assessing the extent of operational damage to main pipelines (MP) with detected flaws of discontinuity: local isolated or multiple surface corrosive metal loss, including, in the case of complex static or fatigue action of the internal pressure and bending moments; corrosion damage on the periphery of the welds of MP and in immediate proximity to them; gas inclusions in the metal of welds; flaws and dents. Minimization of the conservativeness of the proposed estimation is based on

the exact description of the processes of failure of the welded structure at every stage of the integrity violation, and on the minimal schematization of the actual geometry of the structure within the framework of the corresponding finite element partition.

As an example of using the developed complex model for the analysis of welded structures, the limiting state of the pipeline element with a diameter $D = 1420$ mm and a wall thickness $\delta = 20$ mm from 17H1S steel is studied (temperature dependences of properties of this steel, necessary for the calculation of welding processes, are given, in particular, in [20]). It is generally accepted that there is an external semielliptical flaw of a local wall thinning of $s = 50$ mm, $a = 5$ mm, which is permissible according to [21] for typical operating modes (internal pressure up to 7.5 MPa and corresponding safety factors) in the area of the circumferential site seam of the studied part of the MP. The mutual arrangement of a weld seam (taking into account the residual stress-strain state, as well as the scattered damage accumulated during the welding process) and the concentrator in the place of the geometric anomaly has an impact both on the failure mechanisms of the structure metal and the value of the limiting pressure in the pipeline.

At the same time, the failure develops independently in the region of the maximum depth of the flaw and in the HAZ at the initial stages of the structure loading with the internal pressure, whereas the characteristic feature of the limiting state is the interaction between two types of the studied heterogeneities in terms of forming the general zone of microvoids (Fig. 3a). Moreover, the greater the distance dl between the weld seam and the surface wall thinning, the greater the force effect is necessary for the formation of high local stresses and greater metal failure between them, where macro-failure generates at the increase in loading (Fig. 3b). As can be seen from the above data, the close location of the permissible thinning flaw and the weld seam can reduce the bearing capacity of the pipeline to 10 %.

If in addition to the internal pressure, there also acts the bending moment M , which causes a change in axial stresses on the value σ_{zM} depending on the value and direction of the bending force, at the considered MP with an isolated flaw of thinning, the maximum pressure that can withstand the studied pipeline element quasilinearly depends on the magnitude of the moment (Fig. 4). Besides, for the case of a negative bending direction, its effect on the limiting state of the flawed pipeline is relatively small, whereas excessive stretching reduces the P_{max} value to 47 % for the range of values of external moments considered.

In order to assess the impact of the strength characteristics of a specific MP steel on ductile failure processes and the probability of failure, it has been carried out a similar complex boundary analysis for a pipeline $D \times \delta = 800 \times 39$ mm from a steel X60 ($\sigma_Y = 490$ MPa, $\sigma_U = 560$ MPa) with single isolated wall thinning of various sizes. As the results of the study showed, the change of the type of steel within the tube assortment for MP influences considerably the suscepti-

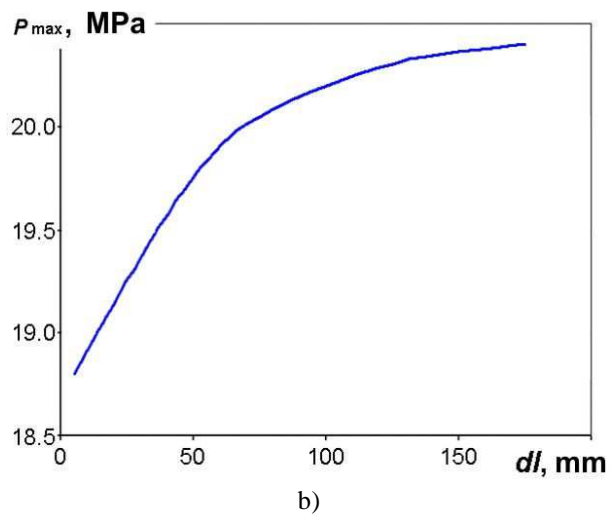
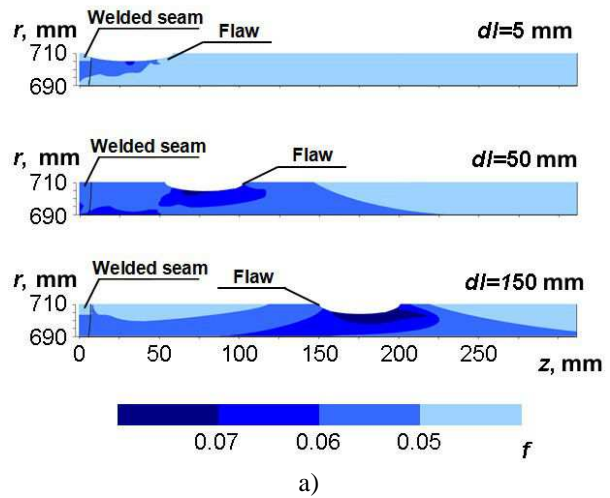

Figure 3 – Distribution of porosity before failure (a) and dependence of the limiting pressure in the pipeline on the distance between the thinning flaw and the circumferential weld (b)

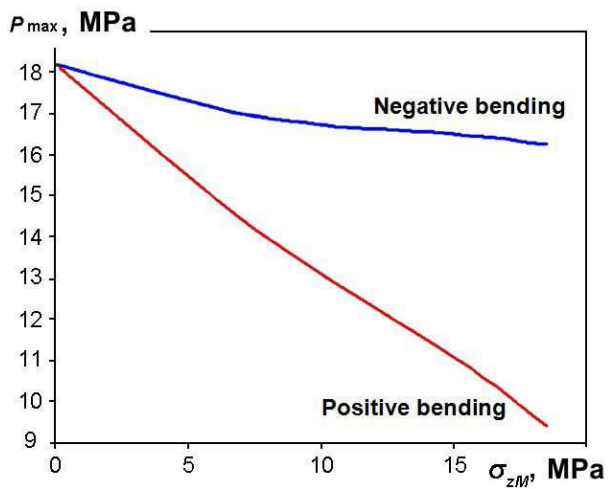

Figure 4 – Dependence of the maximum pressure P_{max} in a pipeline with a three-dimensional flaw of local corrosion thinning and direction of the applied bending moment

bility to variation of failure, and it is mathematically characterized by a decrease of the Weibull parameter B from the value of 4310 MPa up to 2930 MPa with the yield strength increase from 450 to 550 MPa (Fig. 5a). The effect of the strain hardening of the MP material on the value of B is not so significant (see Figure 5 b), which is due to the corresponding changes in the Weibull parameter A .

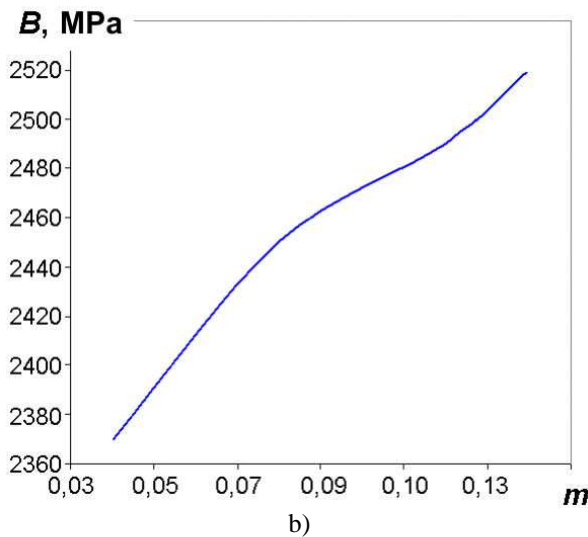
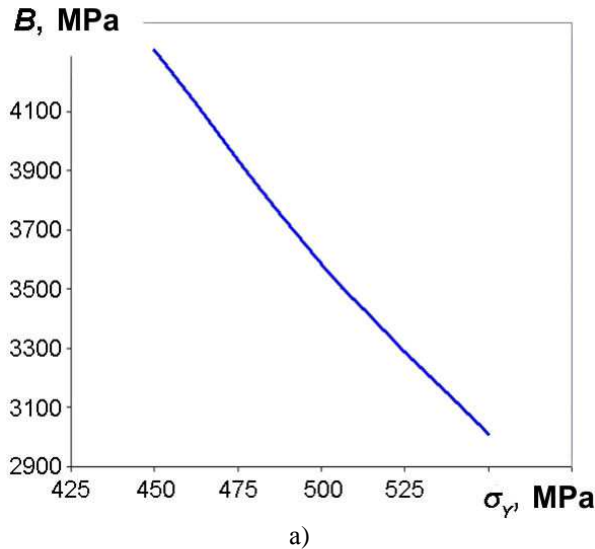
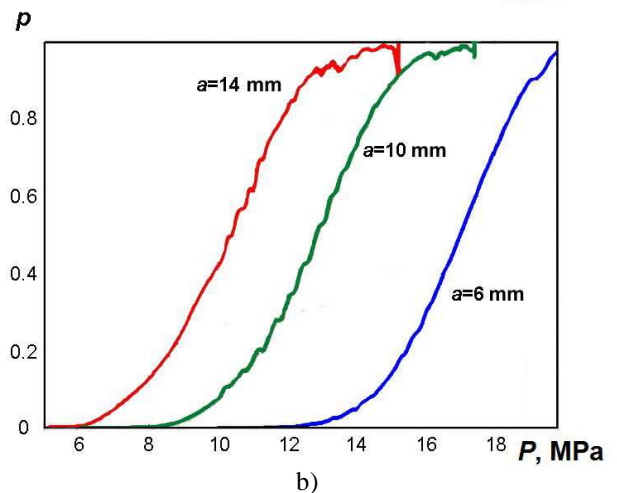
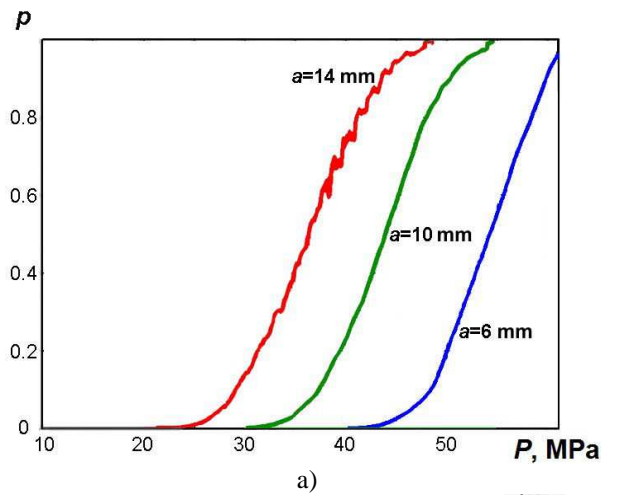

Figure 5 – Dependence of the conservative value of the Weibull parameter B on the yield strength (a) and the strain hardening factor (b) the material of the pipeline flawed section

On the basis of the obtained values of the coefficients of the three-parameter Weibull distribution A and B for 17H1S steel, there was carried out a probabilistic analysis of the state of a pipeline element with a flaw of thinning on the external surface by integrating the field of main stresses, obtained by finite-element solving the boundary-value problem of strain of the mentioned structure under the influence of the internal pressure. In particular, it has been shown that it is possible to determine the maximum allowable values of loads acting on the MP section and the degree of reduction in its bearing capacity with the help of numerical dependences of the probability of the pipeline

failure with surface flaws on the internal operating pressure in the pipeline. As an example of such a calculation Figure 6 shows the dependences of the failure probability on the internal pressure up to the limiting loads for the pipeline $D \times \delta = 800 \times 39$ mm from X80 steel with flaws of different depths at constant lengths and width equal to 150 and 40 mm, respectively. For typical operating ranges of MP operational loads up to 22 MPa, the probability of failure does not exceed $4 \cdot 10^{-4}$, which is acceptable to many pipelines in terms of the overall risk of a failure. Similar flaws have a more significant effect on the bearing capacity of the structure for pipeline $D \times \delta = 1420 \times 25$ mm from X60 steel (see Figure 6 b): flaws with a depth of 10 and 14 mm are not acceptable for a typical operating range of internal pressures (up to 11 MPa) because the failure probability is greater than 0.2 and 0.6, respectively; for a pipeline with a flaw depth of 6 mm, the probability of an failure is $5.1 \cdot 10^{-4}$, which is in most cases acceptable.



$a - D \times \delta = 800 \times 39$ mm, X80 steel;
 $b - D \times \delta = 1420 \times 25$ mm, X60 steel

Figure 6 – Dependence of the failure probability p of the pipeline with flaws of the wall thinning of different depth on the internal pressure P

The calculation results have shown that is not observed a significant difference in the failure probability of the pipeline element at different pressures

in the pipeline for the material with different strain-hardening factors (the difference does not exceed 12 %). This is explained by the fact that differences in the degree of strain-hardening do not cause a significant difference in the limiting pressure for the case under discussion. Therefore, the corresponding functional dependences of the Weibull parameters compensate for the changes in the stress state during the plastic flow of metal in the region of the geometric anomaly, and integrating the field of the main stresses of structure from different materials leads to identical values of the failure probability.

A characteristic feature of the relation (27) is the presence of the spatial component dS/S_0 , which allows taking into account the scale factor of failure in determining the integral probability of the pipeline element failure. As an example, Fig. 7 presents the comparison of the calculation results of the dependence of failure probability on the internal pressure on the pipeline section $D \times \delta = 1420 \times 20$ mm with a three-dimensional flaw of local wall thinning of $2s \times 2c \times a = 150 \times 100 \times 12$ mm and a pipe of $D \times \delta = 710 \times 10$ mm with a three-dimensional flaw of $2s \times 2c \times a = 75 \times 50 \times 6$ mm. As can be seen from the data given, despite the identical distribution of stresses at the same internal pressures for the indicated cases, the failure probability of a larger structure is significantly higher corresponding to the features of failure mechanics.

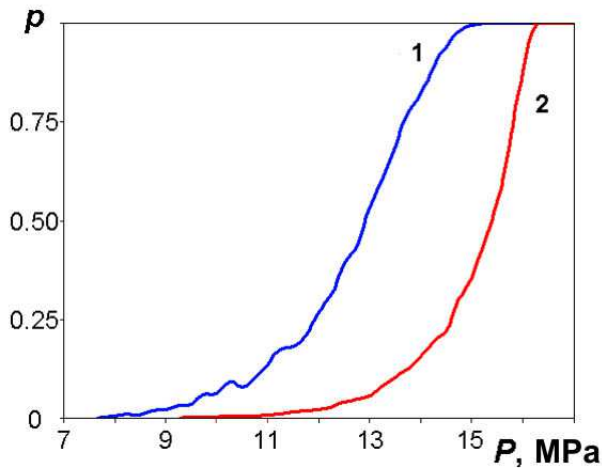

1 – $D \times \delta = 1420 \times 20$ mm, $2s \times 2c \times a = 150 \times 100 \times 12$ mm;
 2 – $D \times \delta = 710 \times 10$ mm, $2s \times 2c \times a = 75 \times 50 \times 6$ mm

Figure 7 – Influence of the scale factor on the failure probability of the pipeline element with a local thinning of the wall under the action of internal pressure

In the case of the joint action of internal pressure and bending moment (see Fig. 2), the change in the bearing capacity of the MP region with a flaw of local thinning, in accordance with existing norms, based mainly on linearly elastic theories of failure, external forces should be considered as additive components in the corresponding admissibility criterion. But the limiting state of the pipeline element in this case is characterized by a substantially nonlinear dependence on the applied load, because of the fact that metal strain

occurs mainly due to the plastic mechanism at the limiting loads and is determined by the value of the main stresses within the framework of the flow condition (12). That is why it can be concluded that the integral analysis of the susceptibility to failure is more adequate by determining the features of the state of the flawed section as it is based on the tracing the strain in accordance with the continual models of prediction of the structure's stressed-strain and damaged states. As an example, it has been considered an element of 17H1S steel MP ($D = 530$ mm, $\delta = 18$ mm) with a flaw of wall thinning ($a=9$ mm, $2s=100$ mm, $2c=80$ mm), affected by the internal pressure P and the bending moment M , the limiting state of the structure corresponds to the values of the Weibull parameters $A = 560$ MPa, $B = 3600$ MPa, $\eta = 4$. The calculated dependences of the failure probability for this example of the flawed section of the pipeline on the operating pressure P at different values of the bending moment (equivalent to the corresponding value of axial stress σ_{zM}) are shown in Fig. 8. In case of small values of P , the dependences are quasilinear, which implies that there is no significant development of plastic strains and ductile failure for this range of values of external forces. But the dependences of the probability of the value p are nonlinear for higher values of P : for pressures higher than 30 MPa there is a sharp increase in the failure probability, which corresponds to the development of both plastic strain and microfracture of the structure metal by the ductile mechanism. In the above example, the bending moment acts in a positive direction relative to the flaw (σ_{zM} have positive values in the flaw section and are negative in the opposite area of the pipe section). For the case of the opposite action of the bending moment, the nature of the failure probability dependencies of the MP with a flaw of thinning on the outer surface is similar, but reducing the axial stresses in the area of the flaw reduces its risk and the corresponding values of the failure probability in all ranges of external force loads variation.

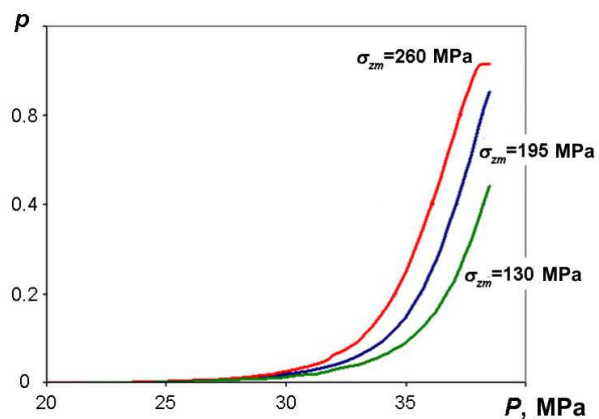

Figure 8 – Dependences of the failure probability of a steel pipeline element with an external flaw of corrosion loss of the metal ($a=9$ mm, $2s=100$ mm, $2c=80$ mm) on the value of internal pressure at different values of the positive bending moment

By means of the described numerical technique there was made a study of the features of the mutual

influence of local metal loss of assembly and repair welded sections under cyclic loading. Without loss of generality, it is considered that the pipeline (diameter $D = 1420$ mm and wall $\delta = 20$ mm) is influenced by the alternating internal pressure $P(t)$, which varies in time t according to the sinusoidal law:

$$P(t) = P_0 + dP \sin\left(2\pi \frac{t}{\tau}\right), \quad (28)$$

where τ is a period of pressure oscillation.

Within the framework of this work, there can be singled out two conservative approaches in determining the onset of the limiting state of a welded structure under the influence of a static, repeated static and low cycle load, namely the appearance of the first imperfections according to the Johnson–Cook criterion (5) or the failure of the first FEs according to the criteria (20). It should be noted that the first approach is not sufficiently informative in the case of the presence of welds in the structure that cause local failure and weakening of the metal. Therefore, the second approach can be considered rational as it defines the nucleation of macro-failure as an inadmissible state of structure. The influence of size of the flaw on the number of load cycles N_f prior to the macro-failure was investigated based on the example of the characteristic case of internal corrosion flaw of the main pipeline element in the area of multipass welding.

Thus, with cyclic change in internal pressure ($P_0=8.0$ MPa, $dP=2.6$ MPa, $\tau=60$ s), when the conditions of ultra low-cycle fatigue are implemented (the number of cycles is not more than 10^3), a micro-failure nucleates at the initial stages of the load in the area of repair welding, and the area of subcritical failure extends into the HAS and the base metal as plastic strains accumulate (see Fig. 9a, b). Macro-failure is typically generated in the field of interaction of plastic strain fields from the concentrator (flaw) and the residual deformed state in the welding zone. The dependence of the limiting number of load cycles for the flaws of different depths in the case under consideration is characterized by a significant nonlinearity (Fig. 9). This is due to the fact that the increase in the depth of the pipeline wall thinning under the zone of repair deposition welding, on the one hand, causes an increase in stresses in the area of a geometric concentrator, and, on the other hand, reduces the amount of deposited metal and the level of post-welding stresses.

Conclusions

1. The methods of numerical prediction of the stress-strain state of steel and aluminum pipeline elements during their assembly and repair welding, as well as in the process of further exploitation, taking into account nucleation, development and interaction of the metal porosity are developed. The criteria of the limiting state of welded structures on the basis of ductile failure mechanics and plastic instability are formulated.

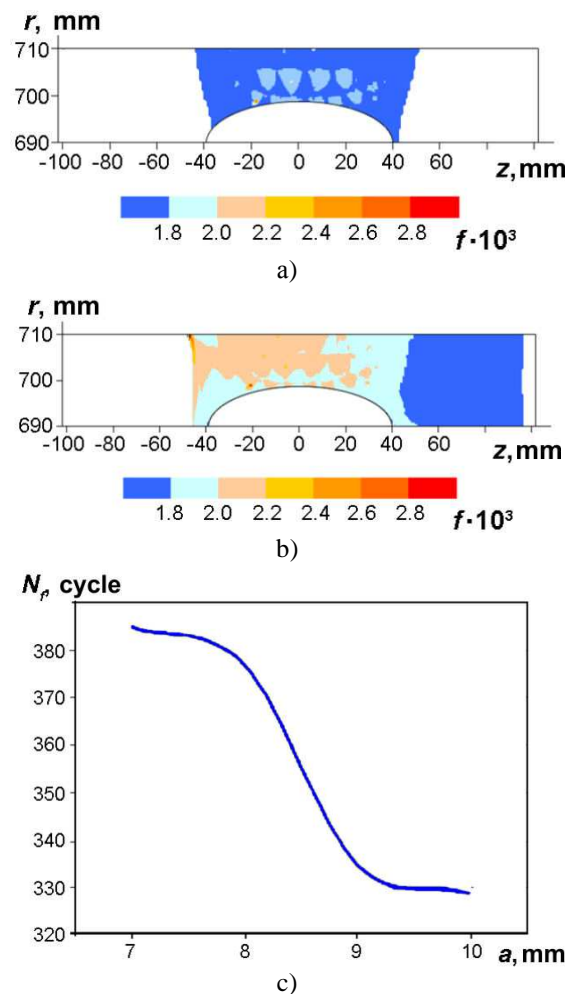

Figure 9 – Distribution of the micro-failure f of a pipeline element metal in the area of deposition welding with an internal flaw of thinning at the first stages of the cyclic loading by internal pressure (a) and before macro-failure (b), and the dependence of the limiting number of load cycles by the internal pressure N_f on the depth of the flaw a (c)

2. There is offered the methodology of numerical estimation of the failure probability of pipeline elements with three-dimensional flaws of metal: surface local thinning and macroscopic gas inclusions in a weld metal based on the integration of the main stress fields within the framework of the three-parameter Weibull statistics. This allows taking into account a complex effect of the internal pressure and the bending moment, and a complex three-dimensional stress-strain state of the pipeline in the area of geometric anomalies. It is shown that the Weibull parameter B is a characteristic of the material and can be used for the probabilistic analysis of the state of pipelines from pipes of various sizes and different type of operational corrosion failure. It is advisable to choose the value of coefficient A equal to the flow stress of a metal for tubular steels with a significant propensity to strainhardening. Conservative values of the Weibull distribution coefficients for steels of different strength classes are obtained.

3. It is shown that the action of the additional bending moment can significantly (up to 60 %) increase

the failure probability of pipelines with flaws of greater width, whereas the increase in the circumference of the geometric anomaly slightly reduces the bearing capacity of the structure under the condition of the action of the purely internal pressure in the pipe.

4. By example of the main pipeline section with the permissible external flaw of the local metal loss near the site welding seam, it is shown that the limiting state of such a flawed structure is characterized by the formation of the general failure area between the welding seam and geometric anomaly.

5. It is shown that the change in the strain-hardening factor the pipeline element material has a significant effect upon the nature of nucleation of distributed failure under the influence of internal pressure. Thus, with a low strain hardening, the microdamaged formation is determined by purely ductile criteria, while the increase in susceptibility to cold-hardening changes the nature of flaws nucleation into brittle-ductile and ductile. The greatest resistance to the failure of the pipeline element by the internal pressure occurs in case of the combined brittle-ductile nature of failure nucleation.

References

- [1] Reutemann, A, Manfredi, C, Otegui, JL & Belmonte, JC 1995, 'Failure Analysis of Power Stations: a Case Study', *Proceedings of an International Symposium on Materials Ageing and Component Life Extension*, ed. V. Bicego, A. Nitta and R. Viswanathan, CISE, Milan, pp. 1357–1365.
- [2] Janelle, JL 2005, *An overview and validation of the fitness-for-service assessment procedures for local thin areas*. University of Akron, USA.
- [3] Wintle, JB, Kenzie, BW, Amphlett, GJ & Smalley, S 2003, *Best practice for risk based inspection as a part of plant integrity management. Contract research report 363/2001*, Health and Safety Executive, Merseyside.
- [4] Makhnenko, VI, But, VS, Velikoivanenko, EA, Rozyuka, GF & Pivtorak, NI 2001, 'Mathematical modelling of pitting flaws in active oil and gas pipelines and development of a numerical method for estimation of permissible parameters of arc welding repair of flaws', *Paton Welding Journal*, no. 11, pp. 2–8. (in Ukrainian).
- [5] Hancock, I & Mackenzie, AC 1976, 'On the mechanism of ductile failure a high strength steel subjected in multi-axial stress state', *Journal of the Mechanics and Physics of Solids*, vol. 24, no. 213, pp. 147–149.
- [6] Alashti, RA, Jafari, S & Hosseini-pour, SJ 2015, 'Experimental and numerical investigation of ductile damage effect on load bearing capacity of a dented API XB pipe subjected to internal pressure', *Engineering Failure Analysis*, vol. 47, pp. 208–228.
- [7] Ruggieri, C & Dotta, F 2011, 'Numerical modeling of ductile crack extension in high pressure pipelines with longitudinal flaws', *Engineering Structures*, vol. 33, no. 5, pp. 1423–1438.
- [8] Dong, P, & Brust, FW 2000, 'Welding residual stresses and effects on failure in pressure vessel and piping components: A millennium review and beyond', *Journal of Pressure Vessel Technology*, vol. 122, no. 3, pp. 329–338.
- [9] Sedmak, A, Younise, B, Rakin, M, Medjo, B & Gubeljak, N 2010, 'Ductile Fracture Resistance of the Weld Metal and Heat Affected Zone in a HSLA Steel Welded Joint' *TCI Meeting*, European Structural Integrity Society, Freiburg, pp. 1–34.
- [10] Frolov, VV (ed.) 1988, *Theory of welding processes*, Vysshaya shkola, Moscow. (in Russian).
- [11] Johnson, GR & Cook WH 1983, 'A constitutive model and data for metals subjected to large strain, high strain rates and high temperatures', *Proceedings of Seventh International Symposium on Ballistics*, Koninklijk Instituut van Ingenieurs, Hague, Netherlands, pp. 541–547.
- [12] Xue, L 2007, 'Damage accumulation and fracture initiation in uncracked ductile solids subject to triaxial loading', *International Journal of Solids and Structures*, vol. 44, no. 16, pp. 5163–5181.
- [13] Tvergaard, V 1990, 'Material failure by void growth to coalescence', *Advances in Applied Mechanics*, vol. 27, pp. 83–151.
- [14] Kartzov, GP, Margolin, BZ & Shvetsova VA 1993, *Physical-mechanical modeling of fracture processes*, Politekhnik, St. Petersburg. (in Russian).
- [15] Makhnenko, VI 2013, 'Problems of examination of modern critical welded structures', *Paton Welding Journal*, no. 5, pp. 22–29. (in Ukrainian).
- [16] Makhnenko, VI 2006, *Resource of safe service of welded joints and assemblies of modern structures*, Naukova Dumka, Kyiv. (in Ukrainian).
- [17] Makhnenko, VI 1976, *Computational methods of investigation of welding stress and strain kinetics*, Naukova Dumka, Kyiv. (in Ukrainian).
- [18] Kitching, R & Zarrabi, K 1982, 'Limit and burst pressures for cylindrical shells with part-through slots', *International Journal of Pressure Vessels and Piping*, vol. 10, no. 4, pp. 235–270.
- [19] Weibull, W 1951 'A statistical distribution function of wide applicability', *Journal of Applied Mechanics*, vol. 18, pp. 293–297.
- [20] Neymark, BE (ed.) 1967, *Physical properties of steels and alloys, used in power engineering. Handbook*, Energiya, Moscow. (in Russian).
- [21] Directive. Determination of residual strength of main pipelines with flaws. DSTU-N B V.2.3-21:2008: Minregionbud of Ukraine. (in Ukrainian).

УДК 621.791+620.19:539.42

Чисельне прогнозування поточних та граничних станів трубопроводів з виявленими недоліками розрідження корозійної стінки

О. С. Міленін

*Інституту електрозварювання ім. Є.О. Патона НАН України;
вул. К. Малевича, 11, м. Київ-150, 03680, Україна*

Наведено основні положення фізичної та математичної моделей спільного розвитку напружено-деформованого стану та пор в'язкого руйнування зварних трубопровідних елементів і посудин тиску з виявленими тривимірними несучільностями металу (локальними корозійними втратами металу, макропорами), у тому числі, в області зварних монтажних швів для визначення характерних особливостей граничного стану дефектних конструкцій. Аналіз напружено-деформованого стану зварної конструкції проводився на основі скінченно-елементного розв'язання задачі нестационарної термопластичності шляхом простежування пружно-пластичних деформацій з моменту початку зварювання до повного охолодження конструкції і подальшого навантаження до граничного стану. В основу континуальної дилатаційної моделі руйнування покладено поетапне прогнозування мікро- та макропошкодження матеріалу конструкції як при зварюванні, так і при навантаженні внутрішнім тиском і зовнішнім силовим моментом згину до граничного стану на базі теорії Гурсона–Твергаарда–Нідлмана. Запропоновано критерії макроруйнування конструкції за крихко-в'язким механізмом.

Розроблено методи ймовірнісної оцінки напруженого стану трубопровідної конструкції з позиції схильності до руйнування, що засновані на інтегруванні розрахункового поля головних напружень в рамках статистики Вейбула. Для коректної кількісної оцінки стану відповідальних конструкцій на основі комплексного аналізу граничного стану сталевих трубопроводів під внутрішнім тиском отримано функціональні залежності параметрів Вейбула від властивостей металу, а саме від границі текучості та ступеня деформаційного зміцнення.

На прикладі типових випадків експлуатаційної пошкодженості елементів магістрального трубопроводу типу локальних поверхневих втрат металу в області монтажного зварного шва досліджено специфіку граничного стану в умовах навантаження внутрішнім тиском і зовнішнім моментом згину. Показано, що характер взаємодії залишкового післязварювального напруженого стану металу з експлуатаційними напруженнями від геометричного концентратора має суттєвий вплив на величину граничного внутрішнього тиску в трубі. Крім того, визначено характер впливу додаткового моменту згину на несучу здатність ділянки трубопроводу з ізольованим дефектом локального корозійного стоншення стінки. На основі результатів інтегрального аналізу стану дефектної ділянки трубопроводу досліджено зміну ймовірності руйнування конструкції від дії внутрішнього тиску та моменту згину при різних геометричних розмірах дефекту стоншення.

Ключові слова: *в'язке руйнування, граничний стан, зварний трубопровід, ймовірність руйнування, математичне моделювання, напружено-деформований стан, тривимірний дефект несучільності.*